



HEAT & GLO

No one builds a better fire

Introducing the Voyageur Grand Zero Clearance Box



VOYAGEUR GRAND WOOD STOVE

QUADRA-FIRE
NOTHING BURNS LIKE A QUAD

*Now you can install a Voyageur Grand
into a timber frame...*

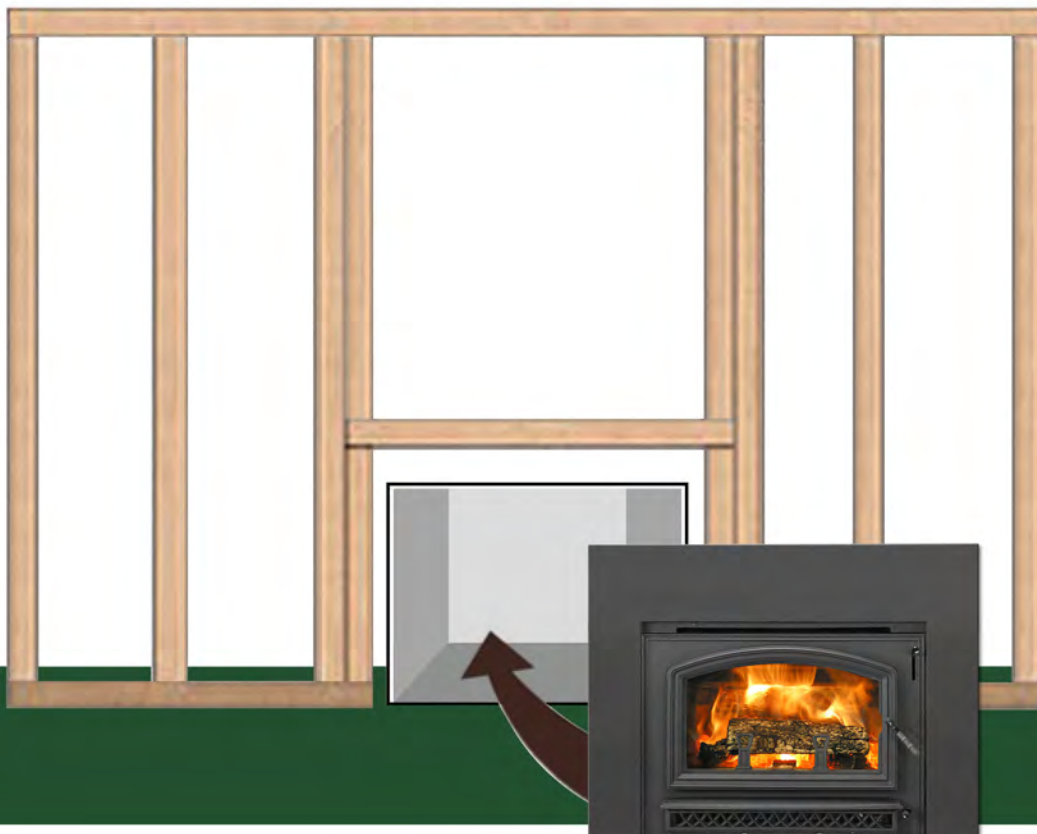

The Grand Voyager Zero Clearance Box allows the product to be installed into a combustible wall, with minimum clearances and without brick or block work using the framing dimensions and clearances illustrated below.

Zero Clearance Box Dimensions

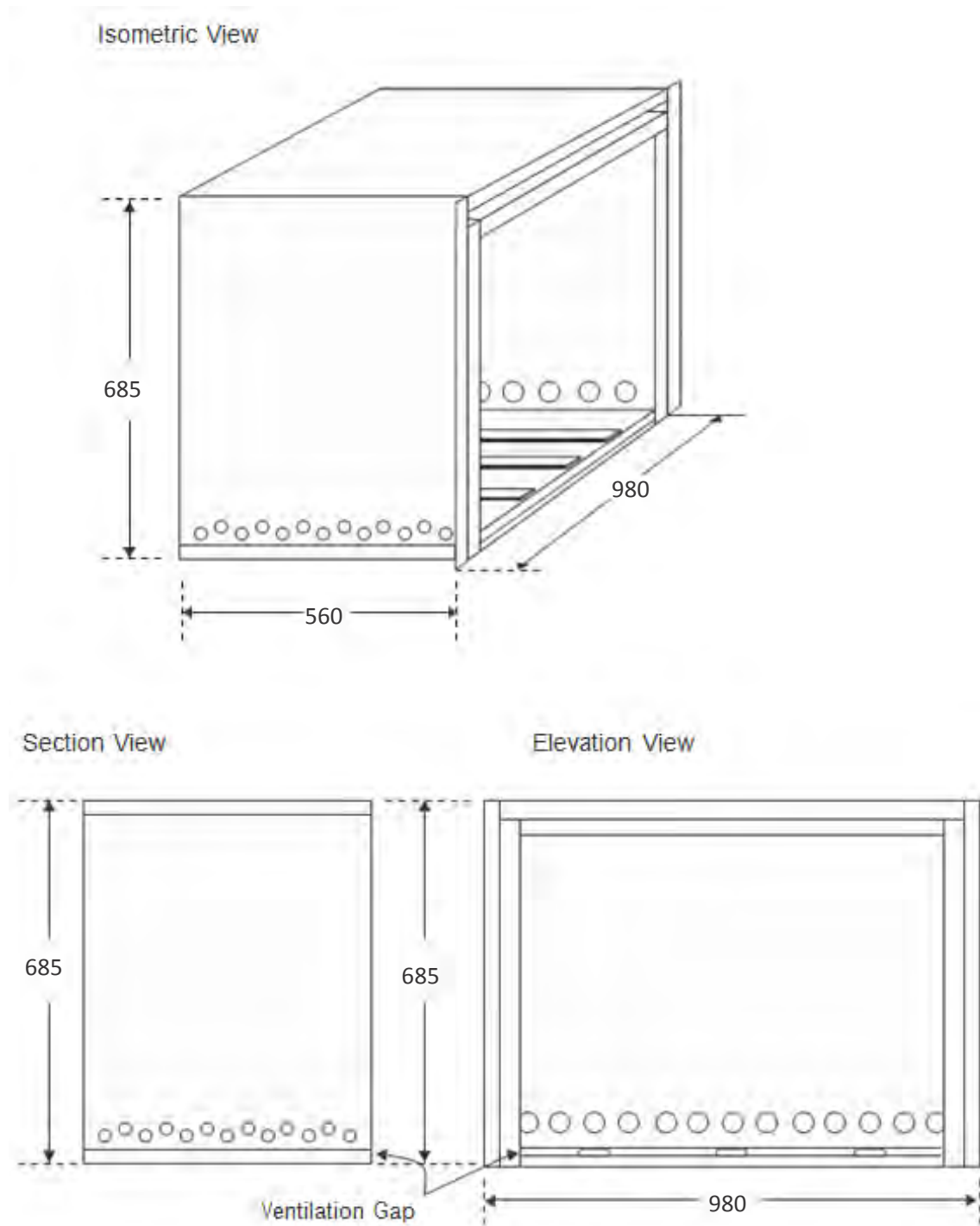

**Dimensions are subject to change at our discretion, please check with our office for further details.

Zero Clearance Box Assembly Details

Step 1

Lay down the bottom panel with folded edges facing upwards, and the non-folded edge turned frontwards.



Step 2

Screw rear spacer, inner left, inner right and inner back panels together, with the returns facing outwards.



Step 3

Screw the inner top panel in place.



Step 4

Screw the 200mm collar in place.

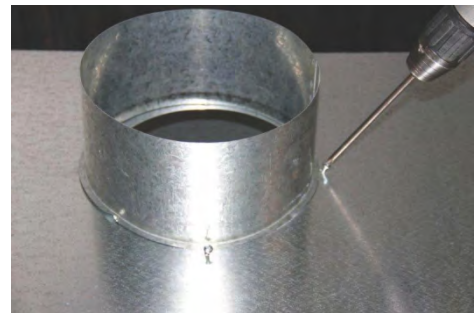

Step 5

Screw the outer left, outer right and outer rear panels in place with the vent holes to the bottom, and the returns facing outwards



Step 6

Screw the outer top panel into place.



Step 7

Screw the 250mm collar in place



Step 8

Stainless bend is supplied to match the height of the triple skins.



The triple skin flue must be installed with a Zero Clearance Box, as per Australian standards. A 25mm clearance from the outer 10" casing to any combustible material must be maintained.

Please see heater owner's manual for other clearances and more information.

* Images for illustration purposes only, some details may change

Framing Dimensions for Zero Clearance Box

PLAN

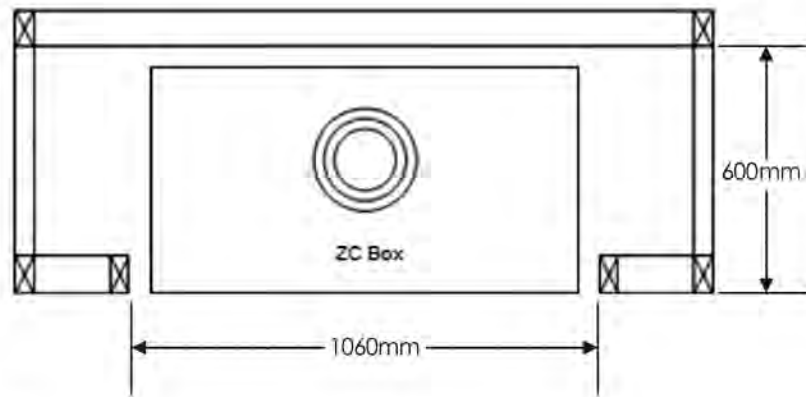

ELEVATION

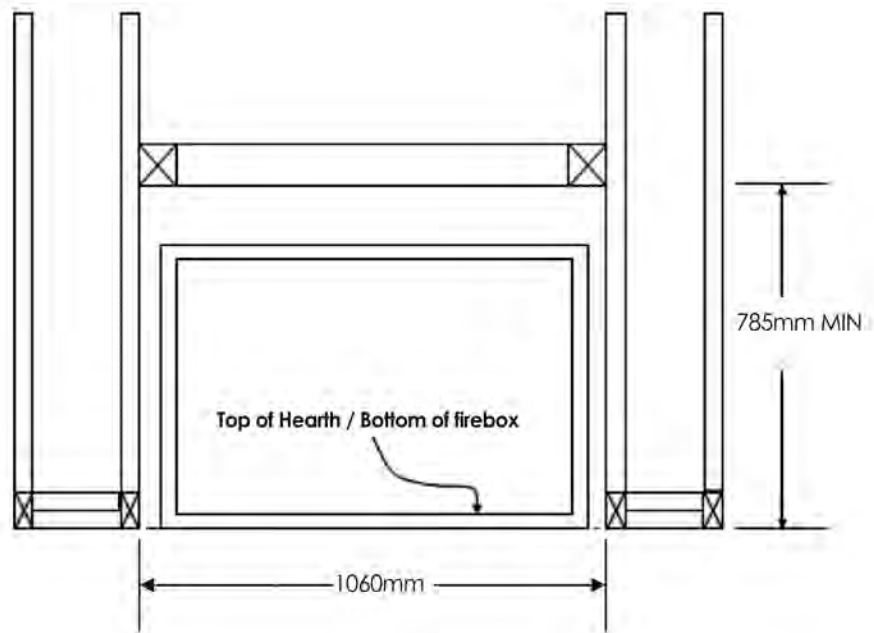

Hearth Requirements for Zero Clearance Box

Isometric View

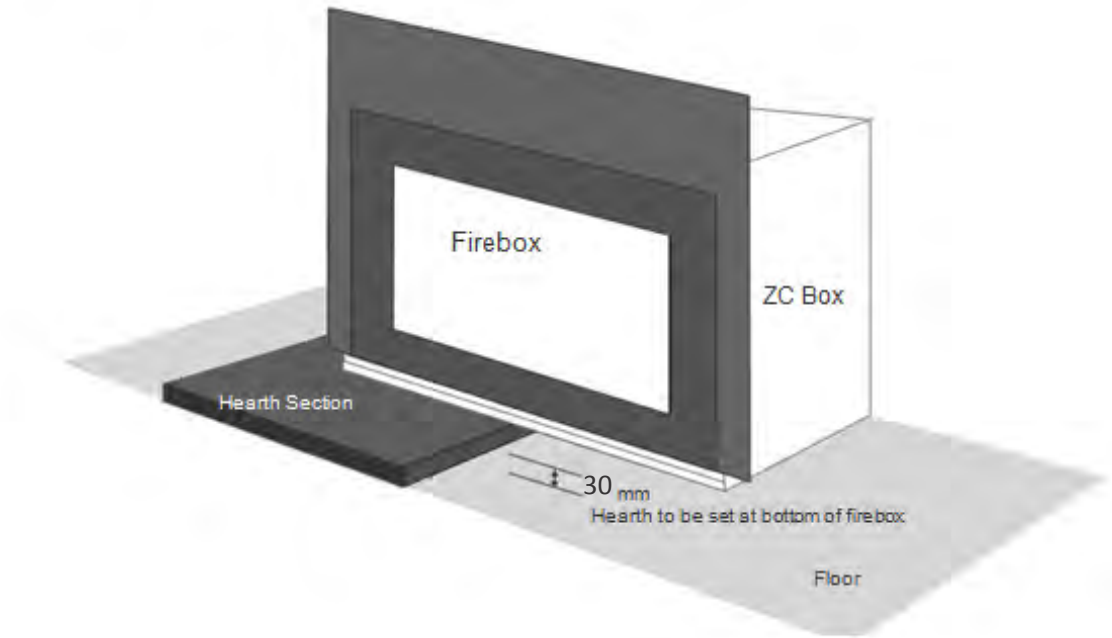

Section View

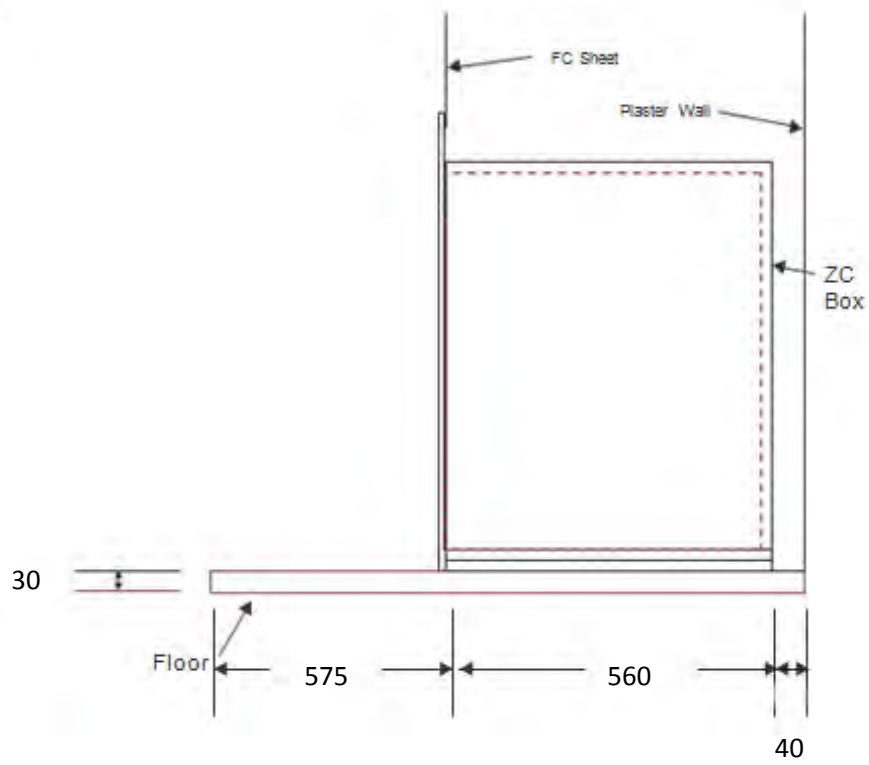

Minimum Clearances & Hearth Requirements for Zero Clearance Box

SECTION VIEW

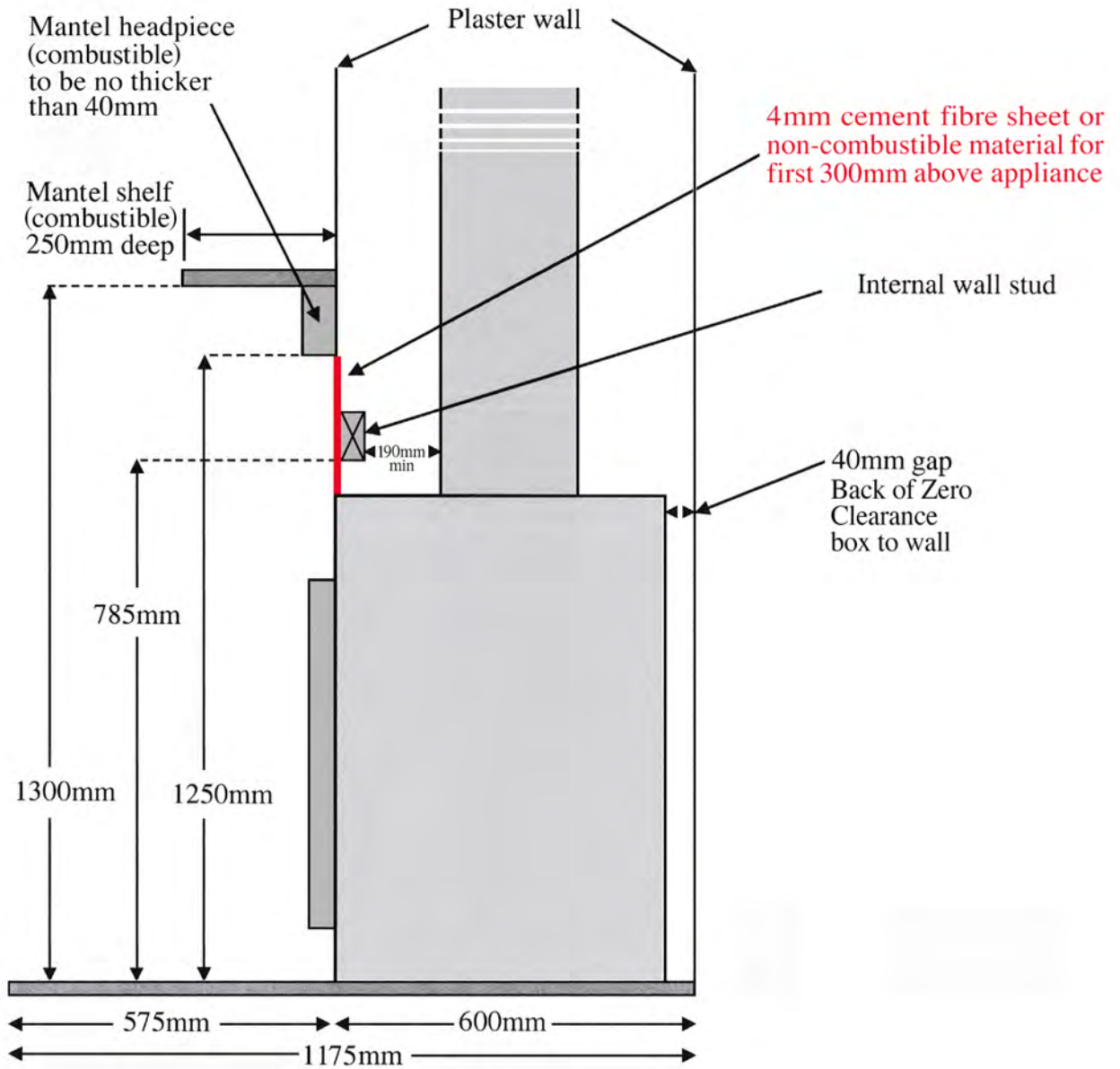

Minimum Clearances & Hearth Requirements for Zero Clearance Box

FLOOR PROTECTOR MINIMUM SIZE REQUIREMENT

Floor Protector to be made of 30mm non-combustible material

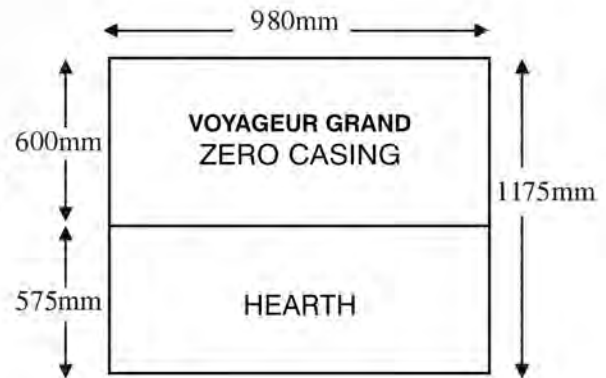



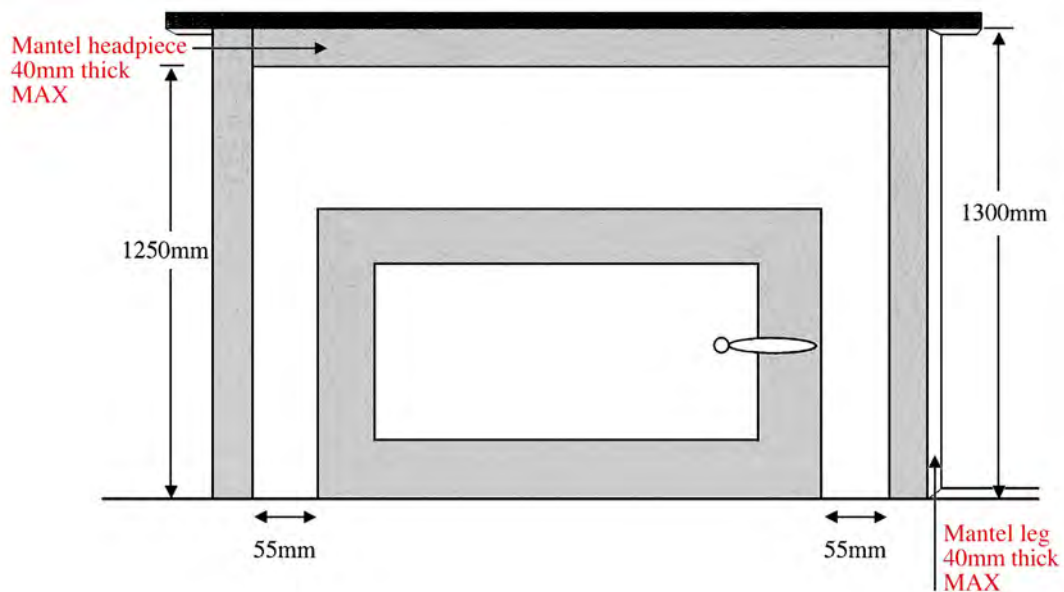





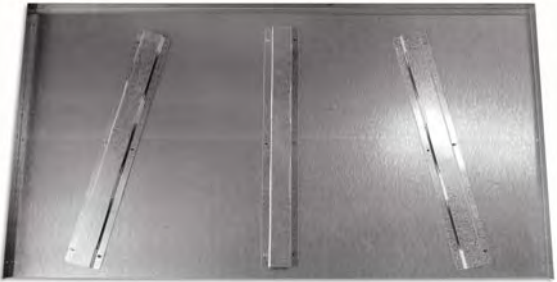

ELEVATION – MANTEL CLEARANCES



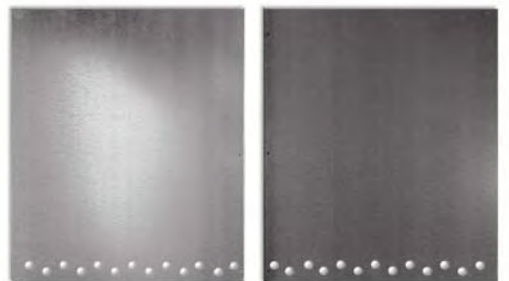

PLEASE NOTE: These specifications relate to Zero Clearance installations only. For installations into an existing fireplace, refer to the Voyageur Grand Installation Manual.

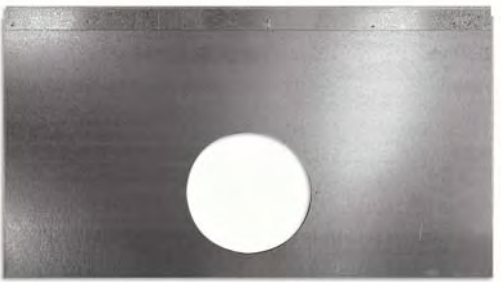
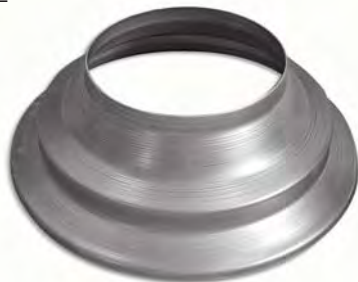
**Dimensions are subject to change at our discretion, please check with our office for further details

VOYAGEUR GRAND ZERO CLEARANCE KIT - Component Listing

<p>BOTTOM PANEL</p> 	<p>FIXING BRACKETS</p> 
<p>INNER SIDE PANELS</p> 	<p>200MM COLLAR</p> 
<p>OUTER SIDE PANELS</p> 	<p>250MM COLLAR</p> 
<p>INNER TOP PANEL</p> 	<p>COWL</p> 
<p>OUTER TOP PANEL</p> 	<p>COVER CONE</p> 
<p>INNER BACK PANEL</p> 	<p>STARTER COLLAR</p> 

<p>4 x 150mm Stainless Steel INNER FLUE</p> 	
<p>4 x 200mm Galvanised FLUE with SPACER</p> 	
<p>4 x 250mm GALVANISED OUTER FLUE</p> 	

JETMASTER HEAT & GLO

444 Swan Street, Richmond

P: (03)9429 5573 E: info@jetmastervic.com.au

W: quadrafire.com.au

