

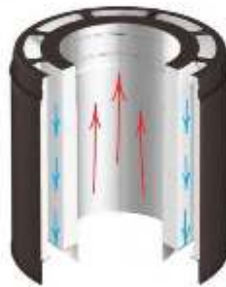

3 Garden Street, Morwell Vic 3840
ABN: 46 610 154 768

PREPARED FOR

JETMASTER (VIC) PTY LTD



THERMAL TESTING OF THE VISIONLINE 200MM SAFETY VENT AIR FLUE KIT IN A FLAT CEILING AND ROOF PENETRATION ACCORDING TO APPENDIX F OF AS/NZS2918:2018

Report Number: ASFT21074-PRELIMINARY REPORT
Issue date: 20 September 2021

By:
Garry W. Mooney

Report Distribution

Jetmaster (Vic) Pty Ltd

444 Swan Road
Richmond Vic 3121

Mr Ashley Stride

ASFT Report Archive

Revision Details

Revision	Date	Comments
0	20/09/2021	Preliminary report – awaiting payment and engineering drawings of Flue Kit

Disclaimer

This Report is intended only for the use of the individual or entity named above (Intended Recipient). ASFT is not liable to the Intended Recipient in respect of any loss, damage, cost or expense suffered as a result of reliance on the information contained in this Report or any actions taken or not taken on the basis of this Report. In particular, results presented in this Report relate exclusively to the samples selected by the Intended Recipient and no responsibility is taken for the representativeness of these samples.

This report shall not be reproduced except in full, without written approval of ASFT.

QD-001R1

Copyright © 2021 ASFT

THERMAL TESTING OF THE VISIONLINE 200MM SAFETY VENT AIR FLUE KIT TO AS/NZS2918:2018 APPENDIX F

Report

The VisionLINE 200mm Safety Vent Air Flue Kit installed in a Flat Ceiling and Roof Penetration was tested according to the joint Australian/New Zealand Standard 2918:2018, Appendix F.

The VisionLINE 200mm Safety Vent Air Flue Kit conforms to the requirements of the joint AS/NZS 2918:2018 Standard, Appendix F when installed in a Flat Ceiling and Roof Penetration.

The Flue system was tested at the following clearances:

Position A – Parallel position

Position B – Corner position

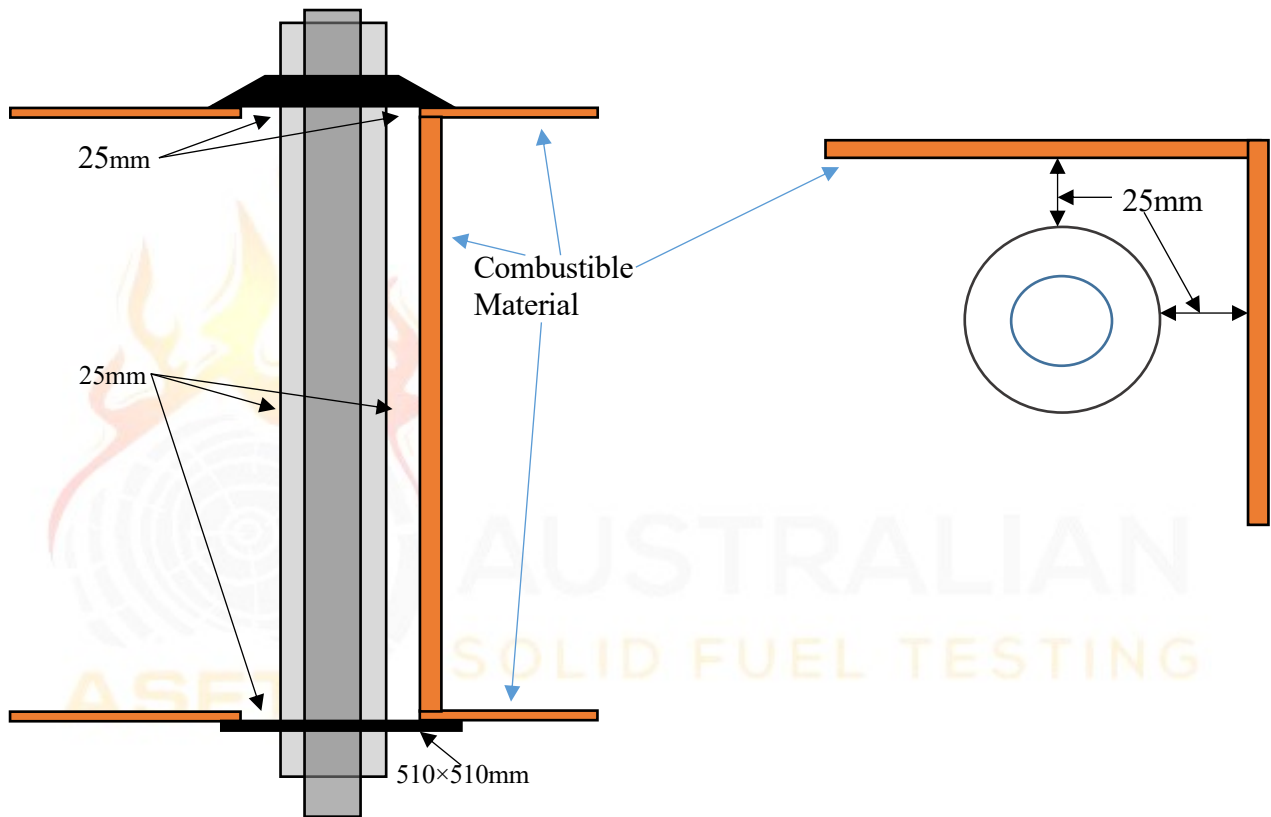

Figure 1 – Clearance Diagram

Signed		Approved	
Name	Garry W. Mooney	Name	Steve Marland
Title	<i>Technical Officer</i>	Title	<i>Managing Director – Australian Solid Fuel Testing</i>
Date	20/09/2021	Date	20/09/2021

1. INTRODUCTION

Thermal Clearance testing of the VisionLINE 200mm Safety Vent Air flue system took place on the 15th of September 2021 at the Australian Solid Fuel Testing Laboratory located at 3 Garden Street, Morwell, Victoria. The testing was performed by Mr G.W. Mooney and Mr S. Marland.

2. PROCEDURE

Testing was conducted as per Appendix F of AS/NZS2918;2018, Hot sites were located with the aid of an infra-red thermometer. Thermocouple tips were stapled onto the test surfaces, with black tape over the first 100 mm to facilitate consistent and accurate recording of temperatures. Thermocouple positions are shown in the table below:

Thermocouple No.	Position	Thermocouple No.	Position
1	Flue gas temperature	17	RHS Wall, 250mm above Ceiling, 200mm from corner
2	Ceiling – Ring Inner Right	18	LHS Wall, 350mm above Ceiling, 200mm from corner
3	Ceiling – 50mm Right	19	RHS Wall, 350mm above Ceiling, 200mm from corner
4	Ceiling – 100mm Right	20	LHS Wall, 450mm above Ceiling, 200mm from corner
5	Ceiling – 150mm Right	21	RHS Wall, 450mm above Ceiling, 200mm from corner
6	Ceiling – 200mm Right	22	LHS Wall, 550mm above Ceiling, 200mm from corner
7	Ceiling – Ring Inner Left	23	RHS Wall, 550mm above Ceiling, 200mm from corner
8	Ceiling – 50mm Left	24	LHS Wall, 1000mm above Ceiling, 200mm from corner
9	Ceiling – 100mm Left	25	RHS Wall, 1000mm above Ceiling, 200mm from corner
10	Ceiling – 150mm Left	26	LHS Wall, 1950mm above Ceiling, 200mm from corner
11	Ceiling – 200mm Left	27	RHS Wall, 1950mm above Ceiling, 200mm from corner
12	LHS Wall, 50mm above Ceiling, 200mm from corner	28	Roof – Ring Inner Front
13	RHS Wall, 50mm above Ceiling, 200mm from corner	29	Roof – Ring Inner Rear
14	LHS Wall, 150mm above Ceiling, 200mm from corner	30	Roof – Ring Inner Left
15	RHS Wall, 150mm above Ceiling, 200mm from corner	31	Roof – Ring Inner Right
16	LHS Wall, 250mm above Ceiling, 200mm from corner	32	Ambient temperature

5. RESULTS

5.1 Ambient and Test Surface Temperatures

The Table below show the Ambient temperatures during testing of the Flue kit.

Hot Fire	Flue Fire
19.7 – 21.3	20.0 – 20.6

5.2 Hot Flue Test

The Flue kit was tested in accordance with Section F8.1 of AS/NZS2918;2018. The Flue gas temperature was maintained at $760 \pm 20^{\circ}\text{C}$ until the maximum temperatures on each surface had been reach.

Below is a table of the maximum temperatures reached above Ambient.

Position	Thermocouple Number	Hot Fire Test ($^{\circ}\text{C}$)
Ceiling	1	14.1
RHS Wall	27	32.1
LHS Wall	26	31.0
Roof	28	38.8

5.3 Flue Fire Test

The Flue kit was tested in accordance with Section F8.2 of AS/NZS2918;2018. The Flue gas temperature was raised from $760 \pm 20^{\circ}\text{C}$ to $1125 \pm 20^{\circ}\text{C}$ within 10minutes, then held at $1125 \pm 20^{\circ}\text{C}$ for a period of 30minutes.

Below is a table of the maximum temperatures reached above Ambient.

Position	Thermocouple Number	Flue Fire Test ($^{\circ}\text{C}$)
Ceiling	1	28.3
RHS Wall	27	71.4
LHS Wall	26	66.6
Roof	28	71.4

5.4 Structural Integrity Test

The VisionLINE 200mm Safety Vent Air Flue Kit was tested in accordance with Section F8.3 of AS/NZS2918;2018. The Flue gas temperature was raised and kept at $760 \pm 20^{\circ}\text{C}$ then raised to $1125 \pm 20^{\circ}\text{C}$ within 10minutes, then held at $1125 \pm 20^{\circ}\text{C}$ for a period of 10minutes. This process was repeated three times.

The VisionLINE 200mm Safety Vent Air Flue Kit was dismantled the following day and the components inspected for their Structural Integrity.

No Structural Integrity issues were found.

5.4 Uncertainty of Measurement Statement

5.5.1 The uncertainty of distance measurement for determining clearance distances was not greater than $\pm 3\text{mm}$.

5.5.2 The uncertainty of temperature measurement during the entire test period was a maximum of $\pm 2^{\circ}\text{C}$ at a 95% confidence level.

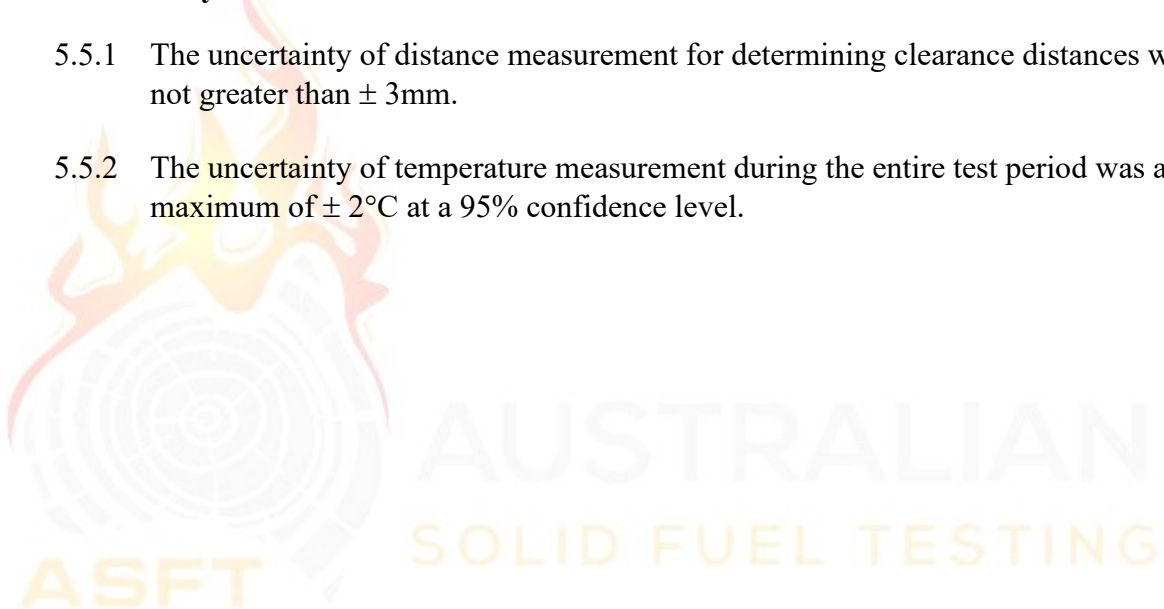

6. FLUE KIT CONSTRUCTION DETAILS

The test results reported directly relate to the Flue kit/flue system tested. The details of the Flue kit given in this section include features which may affect safety clearances. Any change in the design/construction of this Flue kit or flue may invalidate this report. Below are the constructions details of the Flue kit:

Flue Model: VisionLINE 200mm Safety Vent Air	Serial No: N/A
Manufacturer: Jetmaster (VIC) Pty Ltd	
Active Flue diameter: 200mm Length: 1017mm	Material thickness: 0.6mm
Ceiling Plate: 510×510mm	Material thickness: 1mm
Outer Casing below Ceiling diameter: 325mm	Length: 340mm
Lined on inside with 25mm of insulation with 22mm air gap and 15mm insulation	
Material Type/Thickness: 0.6mm stainless steel	
1 st Outer Casing Above Ceiling diameter: 325mm	Length: 1017mm
Lined on inside with 25mm of insulation with 22mm air gap and 15mm insulation	
Material Type/Thickness: 0.6mm stainless steel	
2 nd Outer Casing Above Ceiling diameter: 325mm	Length: 1017mm
Lined on inside with 25mm of insulation with 22mm air gap and 15mm insulation	
Material Type/Thickness: 0.6mm stainless steel	
Cowl Height: 318mm Diameter: 395mm	Material Type: Stainless Steel
Area of Venting in Cowl: 16,280mm²	
NOTE: Accuracy of measurement is ±5% of the measured value	

Appendix 1 is thermal images of the flue kit during testing
Appendix 2 is the installation manual/Instructions for the flue kit

7. CONCLUSION

The VisionLINE 200mm Safety Vent Air Flue Kit flue kit installed in a Flat Ceiling and Roof Penetration conforms to the requirements of Australian/New Zealand Standard 2918:2018, when tested in accordance with Appendix F.

APPENDIX 1: Thermal images of flue during testing

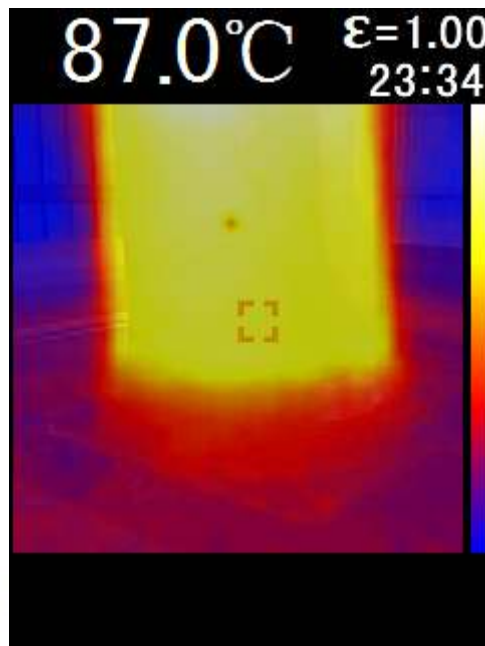

Above Ceiling

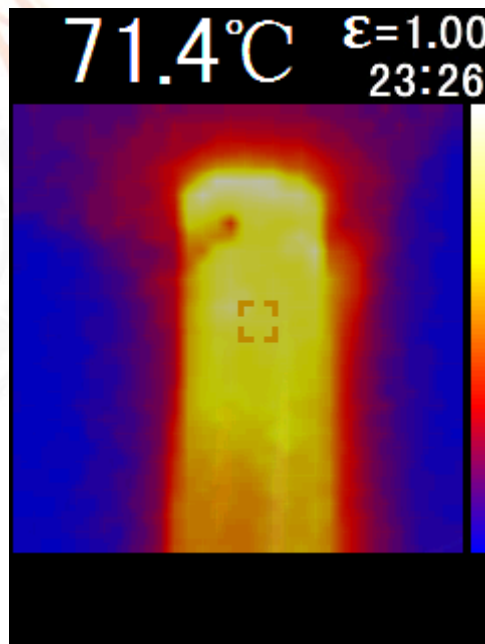

Below Roof



ALIAN
TESTING

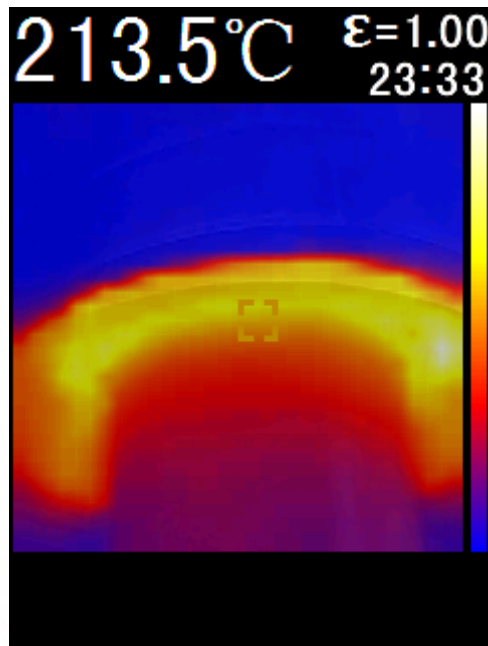

Above Roof

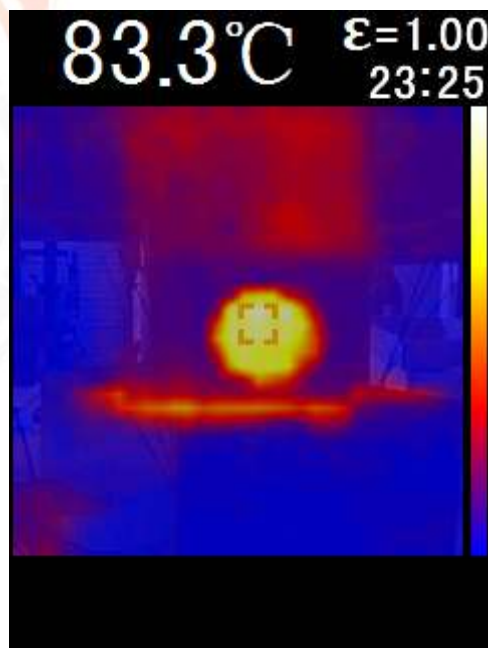

Below Ceiling



ALIAN
TESTING

APPENDIX 2:
Flue Kit Installation Manual Supplied with the flue kit at time of Testing

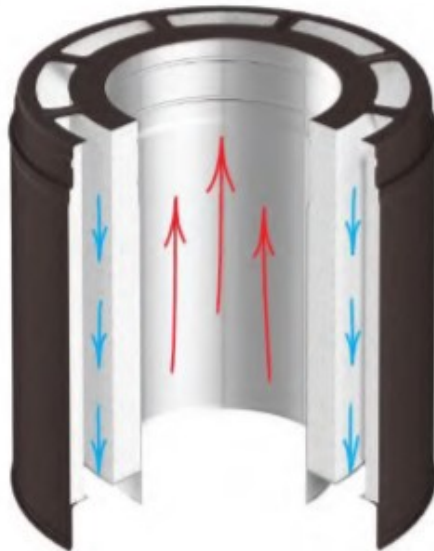

Safety Vent AIR – Instruction Manual

V3 JAN 2019