

## LOGS-COSMO32, LOGS-COSMO36, LOGS-COSMO42

MODELS: COSMO32-IFT, COSMO32-IFT-B, COSMO36-IFT-B, COSMO42-IFT, COSMO42-IFT-B, SLR-X-AU, B41L-AU

### Installation Instructions



Leave this manual with party responsible for use and operation.

**CAUTION! Risk of Cuts or Abrasions.** Wear protective gloves and safety glasses during installation.

**CAUTION:** Logs are fragile, handle with care.

#### KIT COMPONENTS:

- Log Burner Assembly
- Ceramic Logs  
COSMO32-IFT, COSMO32-IFT-B (4)  
COSMO36-IFT-B, B41L-AU (6)  
COSMO42-IFT, COSMO42-IFT-B (6)  
SLR-X-AU (6)
- Glass Baffle  
(COSMO42-IFT-B, COSMO42-IFT Only)
- Lava Rock (1 Bag)
- Mineral Wool (1 Bag)
- Instructions

#### INSTALLATION

1. Remove fixed glass assembly by unlatching the top left and right spring latches. Allow the fixed glass assembly to tilt away from the fireplace and lift the fixed glass assembly up and out of the opening.
2. Remove any existing media from appliance.
3. Remove the base pan assembly by removing two screws located in front of the burner. Use your thumbs and fingertips to grasp the front of the base pan and the flange in the front of the burner respectively. Lift base pan up and out.
4. Begin removal of the burner assembly by removing two screws that secure the pilot hood to the bracket that is attached to the burner. These screws are located on the back side of the pilot hood. Once the screws are removed, slide the pilot hood toward the back wall of the firebox and lift out.  
  
Remove the two screws that attach the pilot assembly to the burner bracket. Remove the screw that fastens the burner bracket to the valve plate. Remove burner by sliding it to the left to disengage the orifice flex. See Figure 1. Discard original burner and media material.
5. Adjust air shutter setting on new burner. See Table 1.

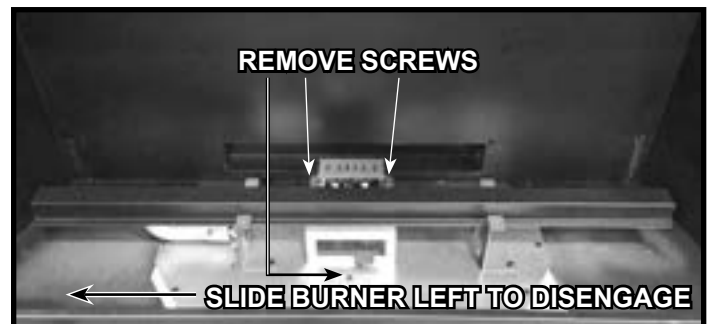


Figure 1. Remove Pilot Screws

**Note:** The burner shutter gap is pre-set at the factory to the "fully open" position and is to be field adjusted at the time of installation. Shutter settings referenced below are set based on the minimum vent configuration (one elbow application). See appliance Installation Manual.

MODEL	GAS TYPE	SETTING
COSMO32-IFT/-B	NG	1/8 in.
COSMO32-IFT/-B	PROPANE	3/16 in.
COSMO36-IFT-B	NG	3/16 in.
COSMO36-IFT-B	PROPANE	5/16 in.
COSMO42-IFT/-B	NG	1/4 in.
COSMO42-IFT/-B	PROPANE	5/16 in.
SLR-X-AU	NG	1/2 in. (13 mm)
SLR-X-AU	PROPANE	5/8 in. (16 mm)
SLR-X-AU	ULPG	5/8 in. (16 mm)
B41L-AU	NG	3/16 in. (5 mm)
B41L-AU	PROPANE	5/16 in. (8 mm)

**Table 1. Air Shutter Settings**

6. Replace standard burner with log burner that is included with log kit. Secure the burner bracket to the valve plate with one screw. Reinstall pilot assembly with two screws. Ensure all excess pilot wires are pushed back down through grommet. Reinstall the pilot hood with two screws. Place base pan in appliance. Reinstall the two screws in front of the burner.

7. Bend tab "up" from basepan to 90 degrees:

**COSMO42-IFT/-B:** Bend 9 tabs and bend air tab. See Figure 3.

**COSMO36-IFT-B, B41L-AU:** Bend 8 tabs. See Figure 16.

**SLR-X-AU:** Bend 7 tabs. Do not bend the two right rear tabs or the air tab. See Figure 3.

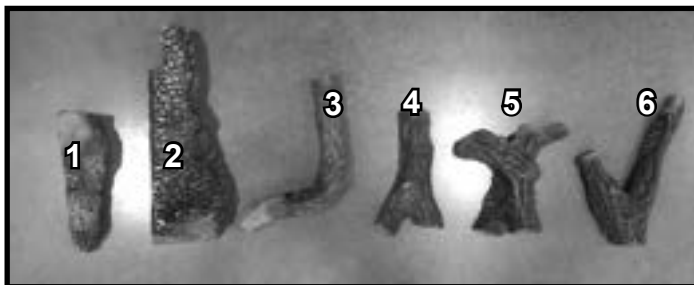
**COSMO32-IFT/-B:** Bend 7 tabs. See Figure 29.

**LOGS-COSMO36, B41L-AU instructions continue with #8 on page 5.**

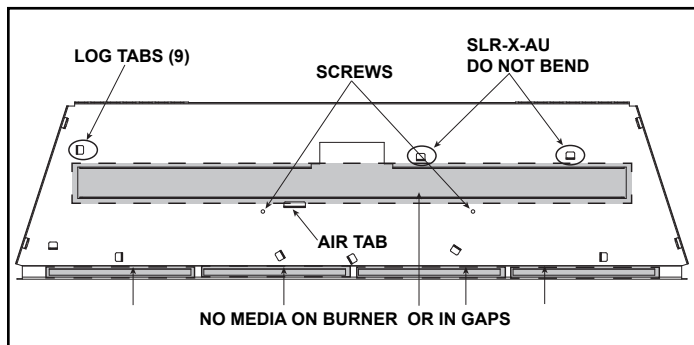
**LOGS-COSMO32, instructions continue with #8 on page 8. Figures continue in sequential order throughout instruction.**

## LOGS-COSMO42 (COSMO42-IFT/ COSMO42-IFT-B / SLR-X-AU)

**NOTICE:** To simplify the installation process, use **Figure 2** to positively identify each individual log before beginning installation.

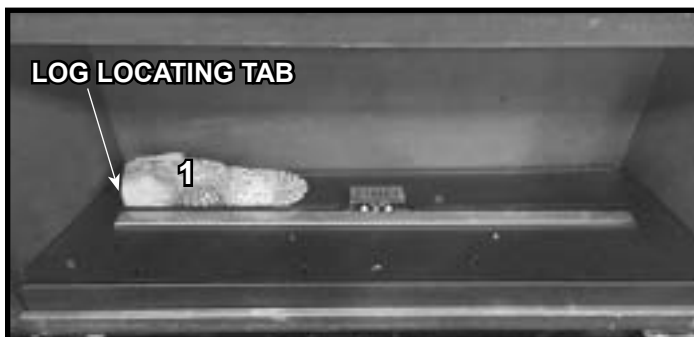


**Figure 2. LOGS-COSMO42**



**Figure 3. COSMO42-IFT/COSMO42-IFT-B Empty Base Pan**

8. Install Log #1 by locating the back left tab behind the burner. Place the log so that the left end is contacting the tab and the front of the log is touching the back sheet metal flange behind the burner. See Figure 4.



**Figure 4. Place Log #1**

9. COSMO42-IFT/COSMO42-IFT-B: Install Log #2 by placing the cutout on the left side of the log over pilot shield and pull log forward until it contacts the two log tabs. See Figure 5.

SLR-X-AU: Install Log #2 by placing the cutout on the left side of log over the pilot shield. Pull log forward until it contacts the rear basepan lip. Note that the tabs are not used.

10. Install mineral wool on burner. Mineral wool can be placed the entire length of the burner, but it must only be placed between the front row of ports and the space in front of the burner. The mineral wool should not cover any ports or fall so that it covers the gap behind of the burner. See Figure 5.

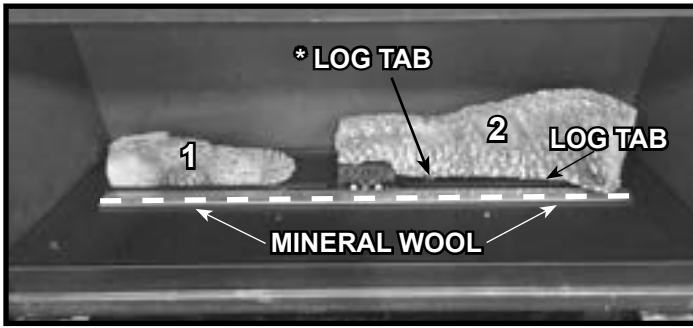


Figure 5. Place Log #2 - Mineral Wool Placement

11. **COSMO42-IFT/COSMO42-IFT-B Only:**

Install Log #3 by positioning front tip of log against front lip of basepan with right side of log contacting log tab. Swing rear tip of log back until it contacts back wall of firebox. Log #3 will rest on Log #1. See Figure 6.

**SLR-X-AU Only:**

Install Log #3 by resting it on top of Log#1. Log #3 will cross the burner and rest on the front lip of the basepan. Right side of log will contact log tab. See Figure 6.

**Note:** When Log #3 is correctly positioned on Log #1, the left side of both logs will line up vertically. See Figure 7. (SLR-X-AU Only)

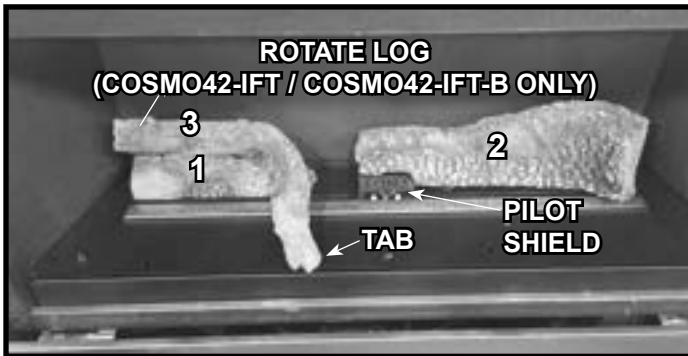


Figure 6. Place Log #3

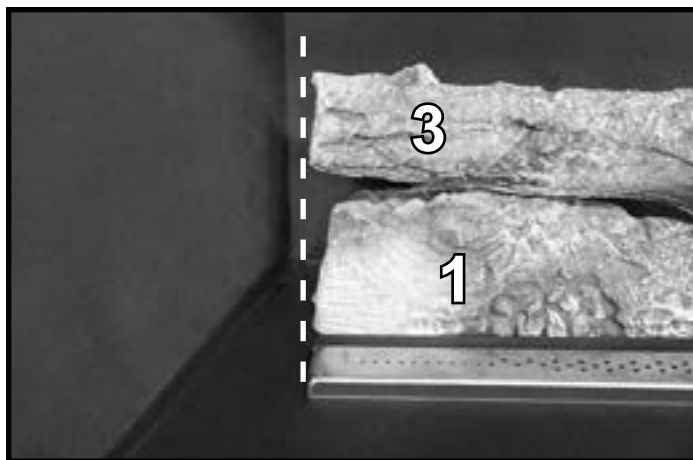


Figure 7. Log #1 and Log #3 Alignment (SLR-X-AU Only)

12. Install Log #4 by placing the forked end down onto the base pan and leaning the top end of Log #4 back so that it is resting on Log #3. The forked end should contact two placement tabs. See Figure 8.

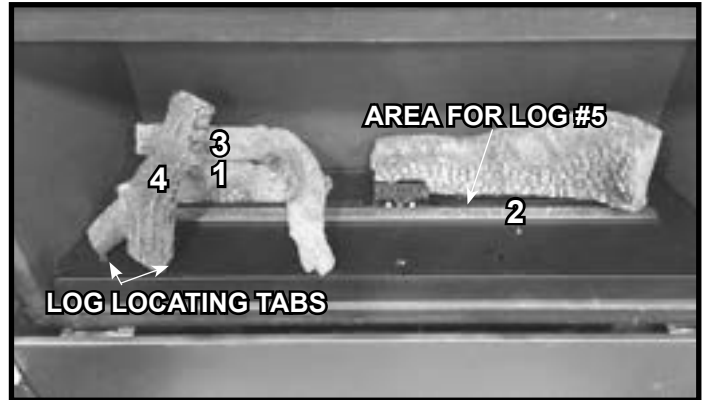


Figure 8. Place Log #4

13. Install Log #5 by placing the forked end down as shown in Figure 9. One side of the fork will rest on Log #3 and the other side of the fork will touch the designated log placement tab. The other end of the log rests on the smooth area on Log #2 noted in Figure 8. See Figure 9.

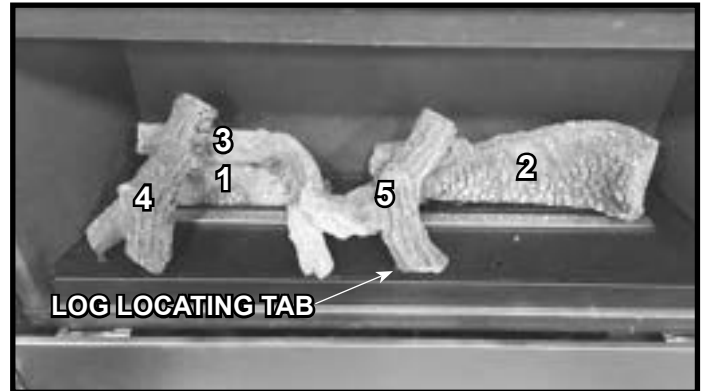


Figure 9. Place Log #5

14. Install Log #6 by placing the right end of the log against the right log tab. The left end of the the log will contact the back side of the tab.

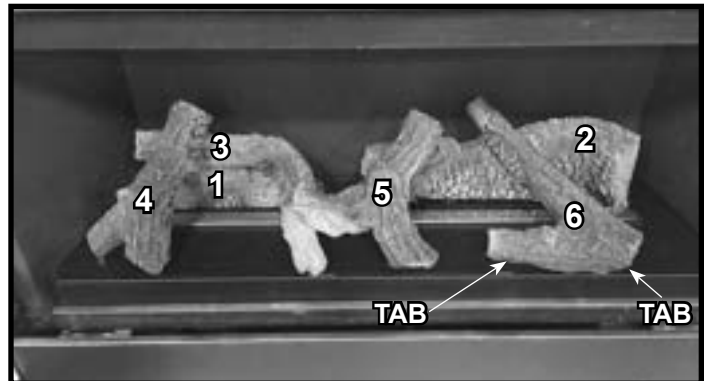


Figure 10. Place Log #6

- Place lava rock onto areas of the base pan to fill in around the logs as desired. It is acceptable to completely cover the base pan. DO NOT cover burner, gaps behind burner, air tab, or block the space in front of the pilot assembly. See Figure 3. Place lava rock in a single layer so no sheet metal is showing. Figure 11 shows lava rock properly placed in relation to logs and areas that must be avoided.

**WARNING! Risk of Delayed Ignition! DO NOT place lava rock on burner. Place only on top of base pan. Fireplace will not function properly. Delayed ignition may occur.**

**WARNING! Risk of Fire! DO NOT place lava rock directly in front of the pilot assembly or cover the burner ports.**

**⚠ WARNING**

**Delayed Ignition Risk**

- Place lava rock according to instructions.
- Do NOT place lava rock in area in front of pilot or directly on burner.
- Do NOT place lava rock in a position that they may fall into area in front of pilot.

- Do NOT use any media other than the lava rock supplied with this kit.
- Do NOT use more than one bag of lava rock per fireplace.
- Do NOT exceed one layer of media on base pan.

Fireplace will not function properly.  
Delayed ignition could occur.

**⚠ WARNING**

**Risk of Asphyxiation or Fumes.**

- Place media according to instructions.
- Do NOT place media in area between glass and firebox.
- Do NOT place media in a position that they may fall into area between glass and firebox.
- Do NOT use any media other than the media supplied with this fireplace.

Fireplace will not function properly.  
Gas leak could occur.

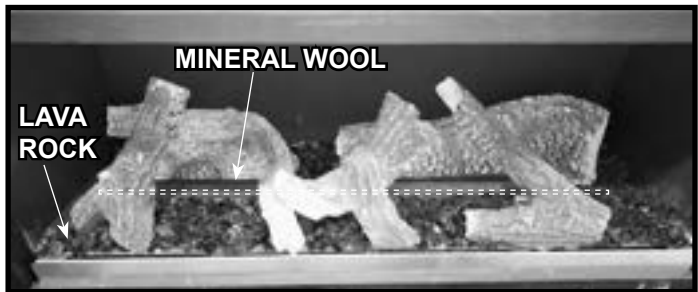


Figure 11. Properly Placed Lava Rock / Location for Mineral Wool

**COSMO42-IFT/COSMO42-IFT-B ONLY:**

- Place the glass baffle into position as shown in Figure 12. Align the glass baffle with the four existing screws located on the inner front top of the firebox. Secure with the two wing nuts included in the kit. See Figure 13. The installed glass baffle is shown in Figure 14.



Figure 12. Glass Baffle Alignment

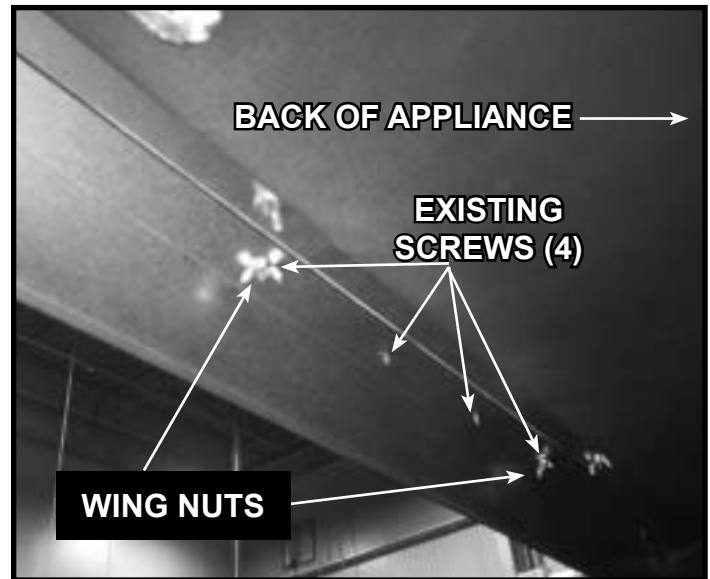


Figure 13. Secure Glass Baffle with Wing Nuts - Inside Top View

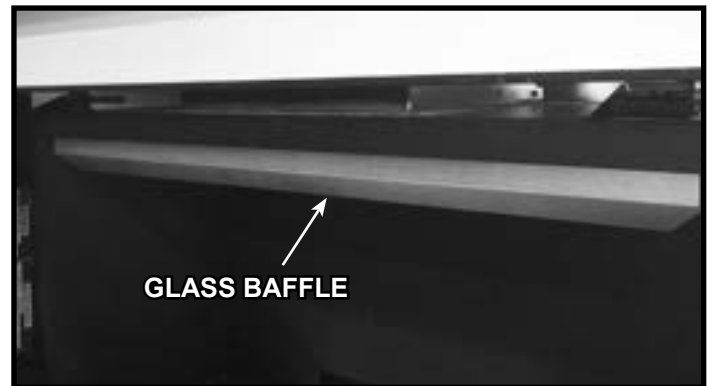


Figure 14. Glass Baffle Installed - Front View

**LOGS-COSMO36  
(COSMO36-IFT-B, B41L-AU)**

**NOTICE:** To simplify the installation process, use Figure 15 to positively identify each individual log before beginning installation.

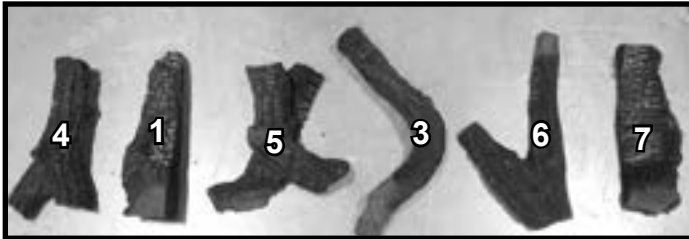


Figure 15. LOGS-COSMO36

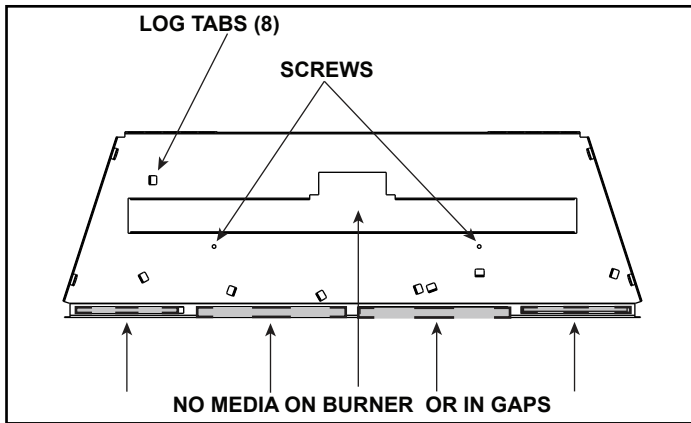


Figure 16. COSMO36-IFT-B Empty Base Pan

8. Install Log #7 by placing the left side of the log touching the pilot shield and pull log forward until it contacts the sheet metal flange behind the burner. See Figure 17.



Figure 17. Place Log #7

9. Install Log #1 by locating the back left tab behind the burner. Place the log so that the left end is contacting the tab and pulled forward until it contacts the sheet metal flange behind the burner. The right end of the log rests on top of the pilot shield. See Figure 18.
10. Place mineral wool on the burner. Mineral wool can be placed the entire length of the burner, but it must only be placed between the front row of ports and the space in front of the burner. The mineral wool should not cover any ports or fall so that it covers the gap on either side of the burner. Refer to Figure 18.

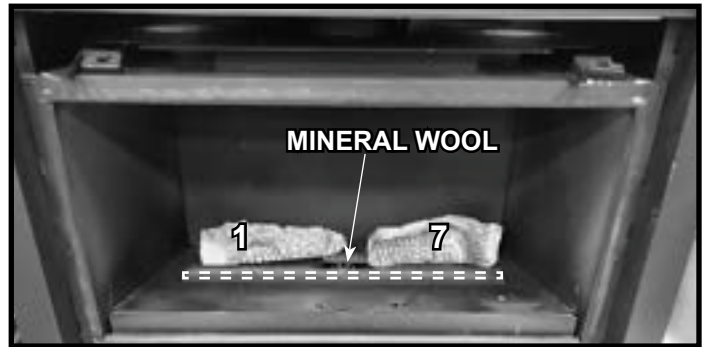


Figure 18. Place Log #1

11. Install Log #3 by resting it on top of Log #1. Log #3 will cross the burner. The tab near the front of the base-pan will rest in the notch in the front tip of the log. See Figure 19.

**Note:** When Log #3 is correctly positioned on Log #1, the left side of the log will be just outside the left end of the burner. See Figure 20.

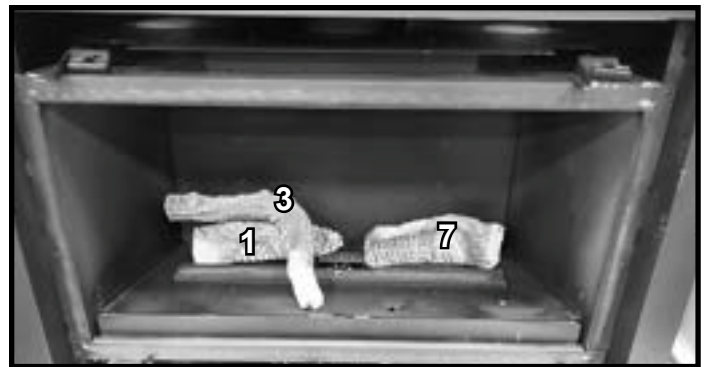


Figure 19. Place Log #3

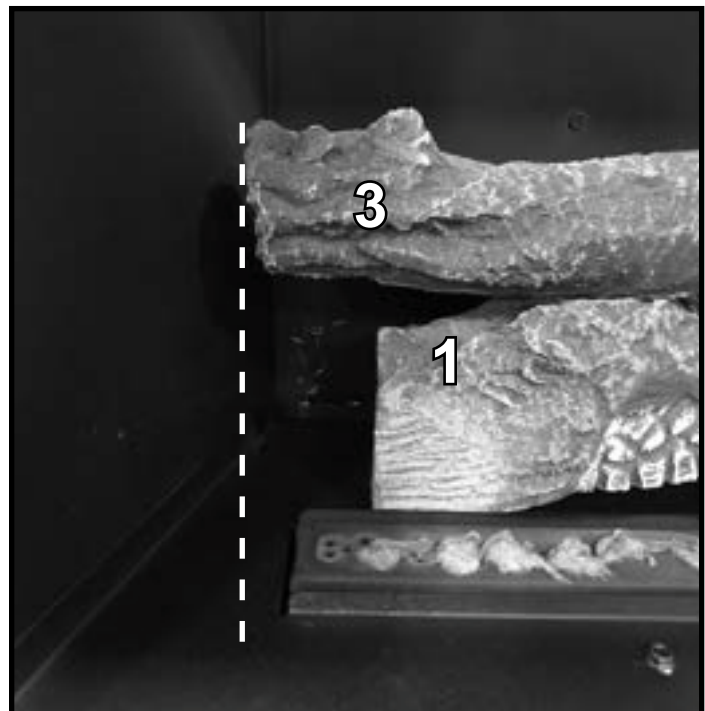


Figure 20. Place Log #3

12. Install Log #6 by placing the right end of the log against the right log tab. The left end of the log will contact the back side of the left tab. The back end of Log #6 will sit on top of Log #7. See Figure 21.

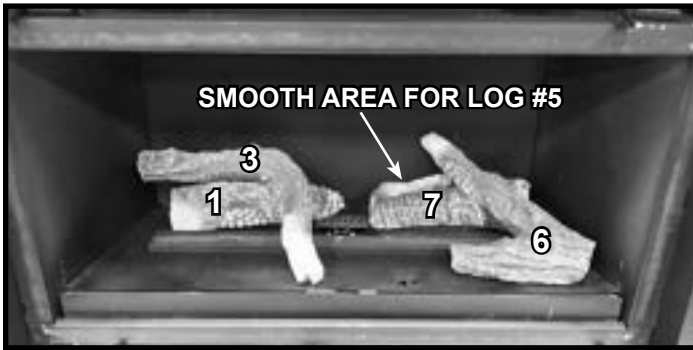


Figure 21. Place Log #6

13. Install Log #5 by placing the forked end down as shown in Figure 22. One side of the fork will rest on Log #3 and the other side of the fork will touch the designated log placement tabs. The other end of the logs rests on the smooth area on Log #7 as noted in Figure 21. See Figure 22.

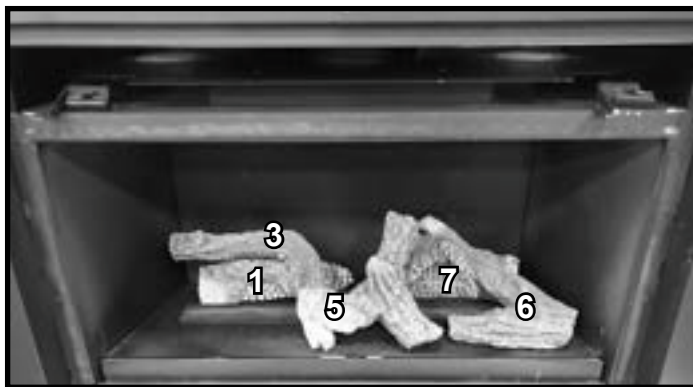


Figure 22. Place Log #5

14. Install Log #4 by placing the forked end down onto the base pan and leaning the top end of Log #4 back so that it is resting on Log #3. The forked end should contact the two log placement tabs. See Figure 23.

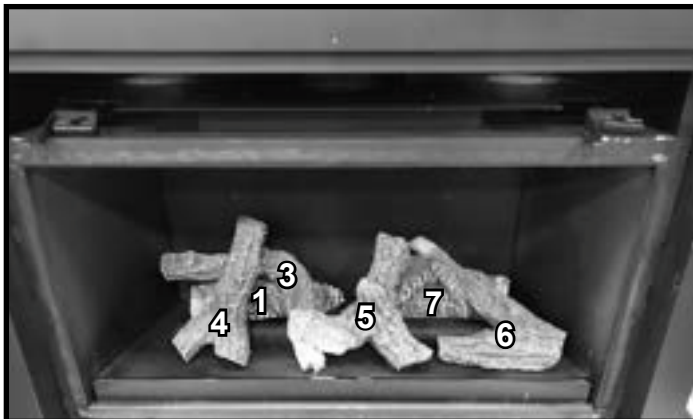


Figure 23. Place Log #4

15. Place lava rock onto areas of the base pan to fill in around the logs as desired. It is acceptable to completely cover the basepan. DO NOT cover burner, gaps behind burner or air tab. DO NOT block the space in front of the pilot assembly. See Figure 16. Place lava rock in a single layer so no sheet metal is showing. Figure 24 shows lava rock properly placed in relation to logs and areas that must be avoided.

**WARNING! Risk of Delayed Ignition! DO NOT place lava rock on burner. Place only on top of base pan. Fireplace will not function properly. Delayed ignition may occur.**

**WARNING! Risk of Fire! DO NOT place lava rock directly in front of the pilot assembly or cover the burner ports.**

**⚠ WARNING**

Delayed Ignition Risk

- Place lava rock according to instructions.
- Do NOT place lava rock in area in front of pilot or directly on burner.
- Do NOT place lava rock in a position that they may fall into area in front of pilot.

- Do NOT use any media other than the lava rock supplied with this kit.
- Do NOT use more than one bag of lava rock per fireplace.
- Do NOT exceed one layer of media on base pan.

Fireplace will not function properly.  
Delayed ignition could occur.

**⚠ WARNING**

Risk of Asphyxiation or Fumes.

- Place media according to instructions.
- Do NOT place media in area between glass and firebox.
- Do NOT place media in a position that they may fall into area between glass and firebox.
- Do NOT use any media other than the media supplied with this fireplace.

Fireplace will not function properly.  
Gas leak could occur.

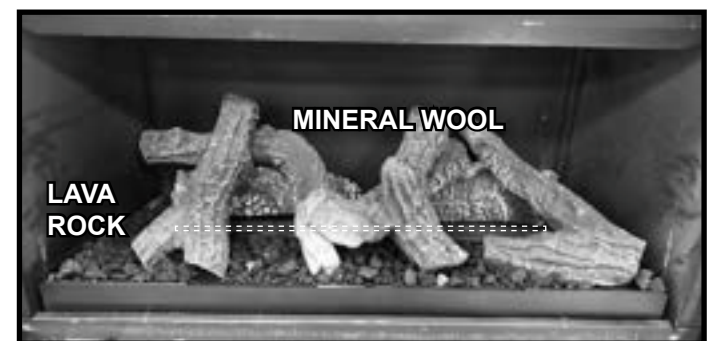


Figure 24. Properly Placed Lava Rock / Location for Mineral Wool

## LOGS-COSMO32

**NOTICE:** To simplify the installation process, use Figure 25 to positively identify each individual log before beginning installation.

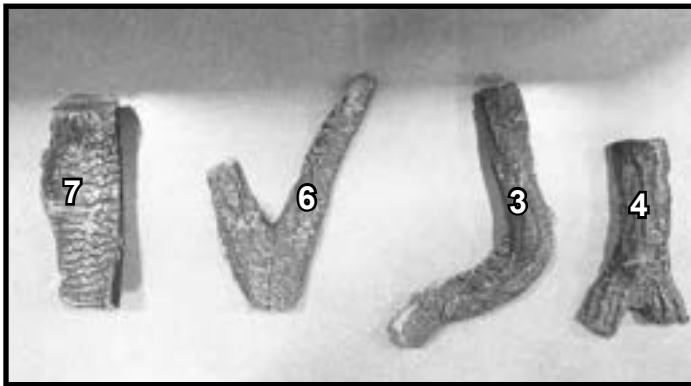


Figure 25. LOGS-COSMO32

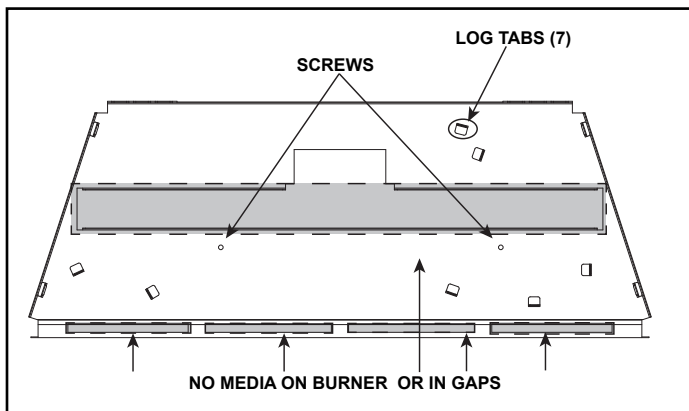


Figure 26. COSMO32-IFT/COSMO32-IFT-B Empty Base Pan

8. Install Log #7 by setting it on the base pan behind the pilot hood and sliding it right until it contacts both placement tabs behind the burner. The placement tabs should be bent up at 90 degrees from the base pan. See Figure 27.

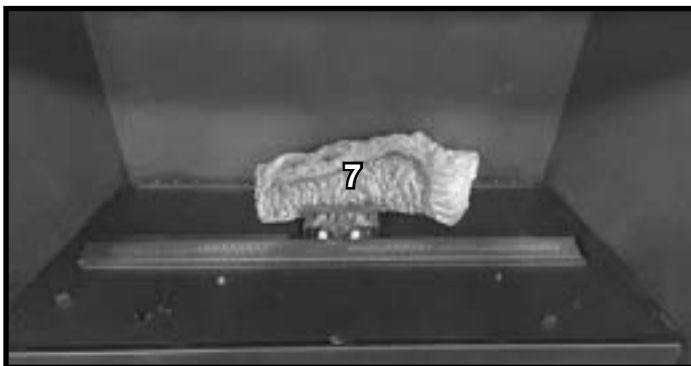


Figure 27. Place Log #7

9. Install Log #6 by locating the placement tabs in front of the burner near the front right corner of the base pan. Set Log #6 on the base pan and bring it forward so that it contacts the front two placement tabs. Slide Log #6 to the right until it contacts log placement tab on right side of basepan. Log #6 should lean back and rest on Log #7. See Figure 28.

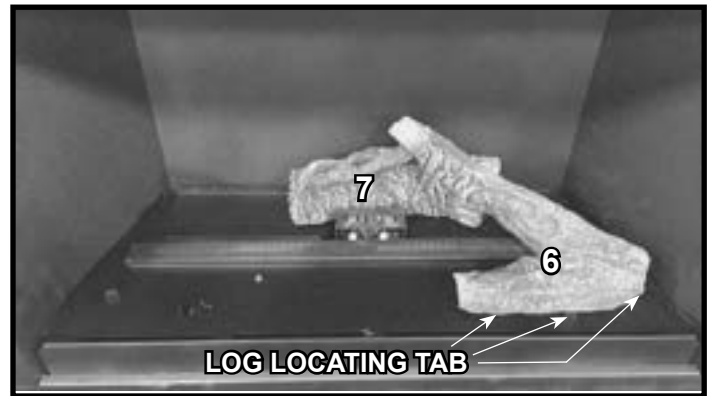


Figure 28. Place Log #6

10. Install Log #3 by placing it on the base pan as an arch where one end contacts the back left corner of the firebox and the other end rest on the sheet metal between two air slots on the front of the base pan. Log #3 should lean back and rest on Log #7. See Figure 29.

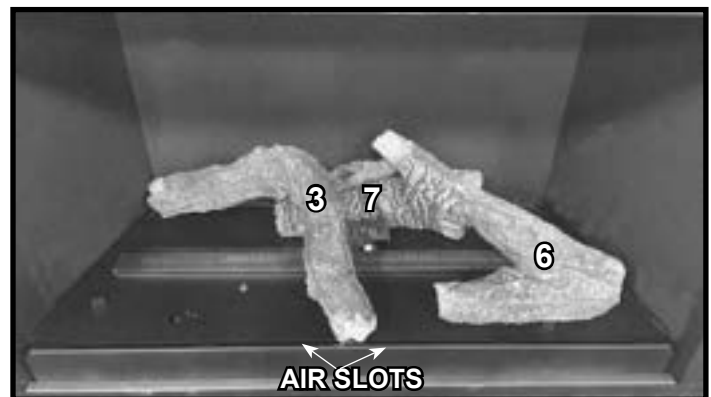


Figure 29. Place Log #3

11. Install Log #4 by placing the forked end down onto the base pan so that each fork is contacting the placement tabs as shown in Figure 30. Lean Log #4 back so it rests on Log #3.

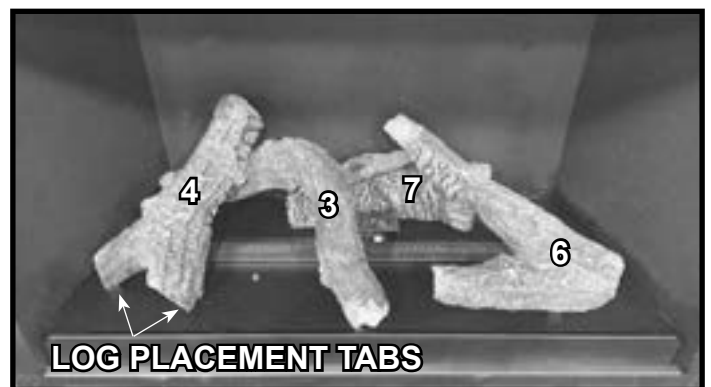


Figure 30. Place Log #4

12. Place lava rock onto areas of the base pan to fill in around the logs as desired. It is acceptable to completely cover the base pan. DO NOT cover burner, gaps in front or behind burner, or block the space in front of the pilot assembly. Place lava rock in a single layer so no sheet metal is showing. Figure 31 shows lava rock properly placed in relation to logs and areas that must be avoided.

**WARNING! Risk of Delayed Ignition! DO NOT place lava rock on burner. Place only on top of base pan. Fireplace will not function properly. Delayed ignition may occur.**

**WARNING! Risk of Fire! DO NOT place lava rock directly in front of the pilot assembly or over the burner ports.**

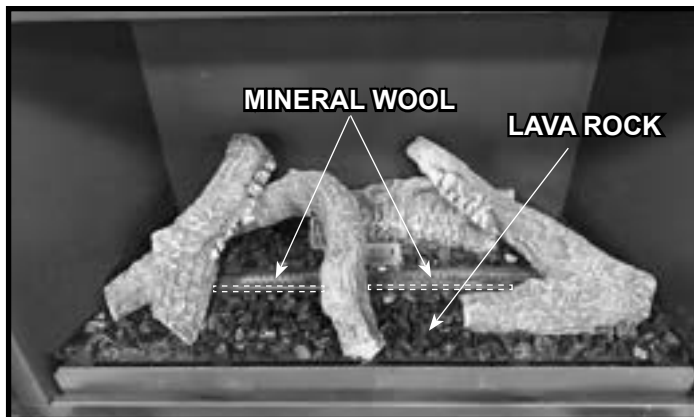



Figure 31. Properly Placed Lava Rock / Location for Mineral Wool

13. The mineral wool may be placed on two areas of the burner, which are highlighted in Figure 31. One area is in the open space between Log #4 and Log #3. The other is in between Log #3 and Log #6. Place the mineral wool onto the burner between the front row of ports and the gap in front of the burner. DO NOT cover the ports or the gap in front of the burner. The mineral wool may be spread along the burner in front of the “viewing windows” between the logs.

**⚠ WARNING**




Delayed Ignition Risk

- Place lava rock according to instructions.
- Do NOT place lava rock in area in front of pilot or directly on burner.
- Do NOT place lava rock in a position that they may fall into area in front of pilot.

- Do NOT use any media other than the lava rock supplied with this kit.
- Do NOT use more than one bag of lava rock per fireplace.
- Do NOT exceed one layer of media on base pan.

Fireplace will not function properly.  
Delayed ignition may occur.

**⚠ WARNING**



Risk of Asphyxiation or Fumes.

- Place media according to instructions.
- Do NOT place media in area between glass and firebox.
- Do NOT place media in a position that they may fall into area between glass and firebox.
- Do NOT use any media other than the media supplied with this fireplace.

Fireplace will not function properly.  
Gas leak may occur.

Please contact your Heat & Glo dealer with any questions or concerns.

For the location of your nearest Heat & Glo dealer, please visit [www.heatnglo.com](http://www.heatnglo.com).

Heat & Glo, a brand of Hearth & Home Technologies  
7571 215th Street West, Lakeville, MN 55044  
[www.heatnglo.com](http://www.heatnglo.com)