

ELECTRIC FLAT PANEL FIREPLACE HEATER

Model# : ■ VL-36B ■ VL-45B ■ VL-50B ■ VL-55B
■ VL-60B ■ VL-65B ■ VL-72B ■ VL-100B

OWNER'S MANUAL

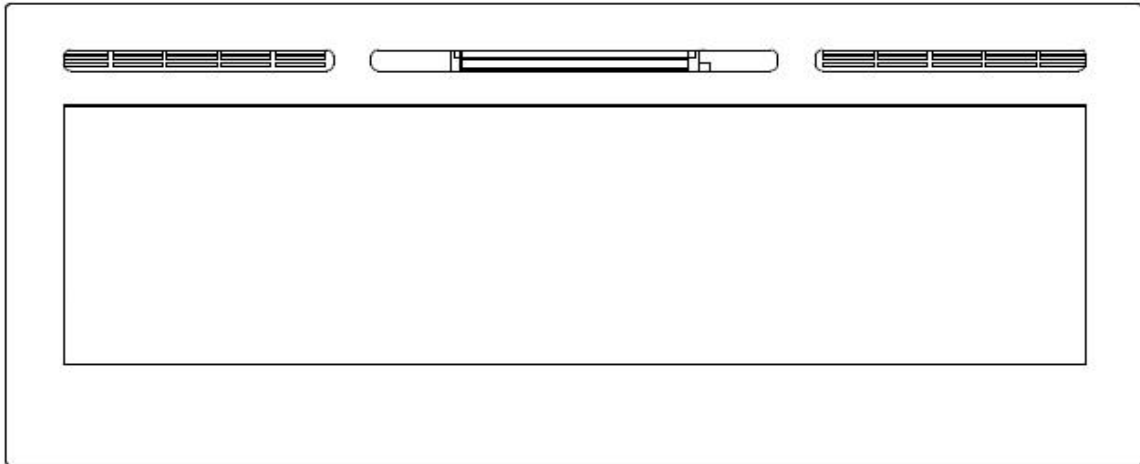

36"/45"/50"/55"/60"/65"/72"/100"
Wall Mounted / Built-in Electric Fireplace

AC 220-240V 50Hz 1400-1600W

⚠ WARNING

Read and understand this entire owner's manual, including **all safety information**, before **plugging in** or **using** this product. Failure to do so could result in **fire, electric shock, or serious personal injury**.

⚠ CAUTION

Keep this owner's manual for future reference. If you sell or give this product away, **make sure this manual accompanies this product**.

visionLINE™
fireplace systems

IMPORTANT SAFETY INFORMATION!

WARNING

- **Read all instructions before using this heater!**
- This heater is **hot when in use**. To avoid burns, **DO NOT** let bare skin touch **hot** surfaces. If provided, use handles when moving this heater. Keep **combustible materials**, such as furniture, pillows, bedding, papers, clothes, and curtains at least **3 feet (0.9m)** from the **front of the heater**, and **keep them away from the sides and rear**.
- **Extreme caution** is necessary when any heater is used by or near **children** or **invalids** and whenever the heater is left **operating and unattended**.
- **DO NOT** operate any heater with a **damaged cord or plug** or after the **heater malfunctions**, has been **dropped** or **damaged in any manner**. Discard heater, or return to authorized service facility for examination and/or repair.
- **DO NOT** run **power cord** under carpeting. **DO NOT** cover power cord with throw rugs, runners, or similar coverings. **DO NOT** route power cord under furniture or appliances. Arrange power cord **away from traffic** area, and where it will not be tripped over.
- **Connect to properly grounded outlets ONLY.**
- **DO NOT** insert or allow foreign objects to enter any ventilation or exhaust opening, as this may cause **electric shock** or **fire**, or **damage the heater**.
- To prevent a possible fire, **DO NOT** block air intakes or exhaust in any manner. Doing so could cause a **fire**. **DO NOT** use on soft surfaces, like a bed, where openings may become blocked.
- A heater has **hot and arcing or sparking parts inside**. **DO NOT** use it in areas where **gasoline, paint, or flammable liquids** are used or stored.
- **Use this heater only as described in this manual. Any other use not recommended by the manufacturer may cause fire, electric shock, or injury to persons.**
- **ALWAYS** plug heaters directly into a wall outlet/receptacle. **NEVER** use with an extension cord or relocatable power tap (outlet/power strip).
- **DO NOT** place the heater near a bed because objects such as pillows or blankets can fall off the bed and be ignited by the heater.
- **NEVER** use this heater in **bathrooms, laundry rooms**, or any other location where the heater could fall into a **bathtub** or **pool**, **become damp**, or **come in contact with water**.
- **AVOID FIRE!** Regularly inspect all air vents to make sure they are free from dust, lint, or other blockage. **Unplug the unit** and clean with a **vacuum ONLY**. **DO NOT** rinse or get wet.
- **ALWAYS** mount to wall bracket before use. **DO NOT** set on the floor, or other surface, to use.
- **NEVER** use a wall mount bracket from another manufacturer.
- This product is **not intended** to be a **primary heat source**. It is for **supplemental heat only**.
- **INDOOR use only! NEVER** use this heater **outdoors!** Doing so may result in **electric shock!**
- **Risk of electric shock! DO NOT OPEN!** No user-serviceable parts inside!

- **ALWAYS** turn this heater off before unplugging it from the outlet.
- **ALWAYS disconnect** this unit from the **power** supply **before** performing any assembly or cleaning, or before relocating the electric fireplace.
- **NEVER** leave this heater unattended. **ALWAYS** unplug this heater when not in use.
- **ALWAYS** store this heater in a dry location. **NEVER** use the fireplace if it has become wet.
- **NEVER** plug this heater into an outlet that is **old, cracked,** or has any **loose wires or connections.** Plugging this heater into a faulty outlet could result in **electric arcing** within the outlet that could cause the **outlet to overheat or catch fire.**
- **ALWAYS** check your heater cord and plug connections with **each use!**
 - i) **MAKE SURE** the plug fits tight in the outlet! Faulty wall outlet connections or loose plugs can cause the outlet to overheat.
 - ii) **Heaters draw more current** than small appliances. **Overheating** may occur even if it has not occurred with the use of other appliances.
 - iii) During use **check frequently** to see if the **plug outlet or face plate is HOT!**
 - iv) If the outlet or face plate is **HOT, discontinue use immediately** and have a qualified electrician inspect and/or replace the faulty outlets.

Preparation







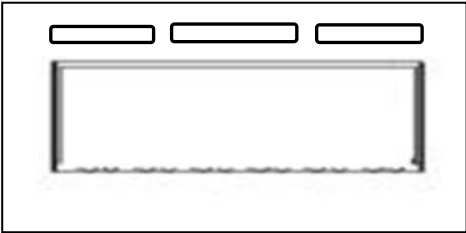

This product includes a **GLASS panel!** Always use **extreme caution** when handling **glass.** Failure to do so could result in **personal injury** or **property damage.**

Remove all parts and hardware from the carton and place them on a clean, soft, dry surface. Parts and assembly steps are grouped for wall-hanging or recessing use. Check the parts list to make sure nothing is missing. Dispose of packaging materials properly. Please recycle whenever possible.

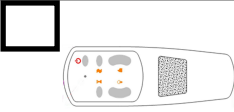
You will need the following tools (not included): Phillips screwdriver; stud finder; level; tape measure; electric drill; 1/4" wood drill bit, hammer.

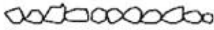
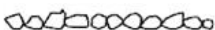
Parts and Hardware

 <p>A – Fireplace</p>		 <p>B – Wood Screws</p>		 <p>C – Drywall anchors</p>
		 <p>Remote Control</p>		
 <p>E-Wall Bracket Fixed on back of firebox</p>	 <p>F-Decorative Pebbles</p>	 <p>G-Decorative Crystals</p>	 <p>H - Log set</p>	 <p>I - Plastic Tray</p>

Specification and Dimension

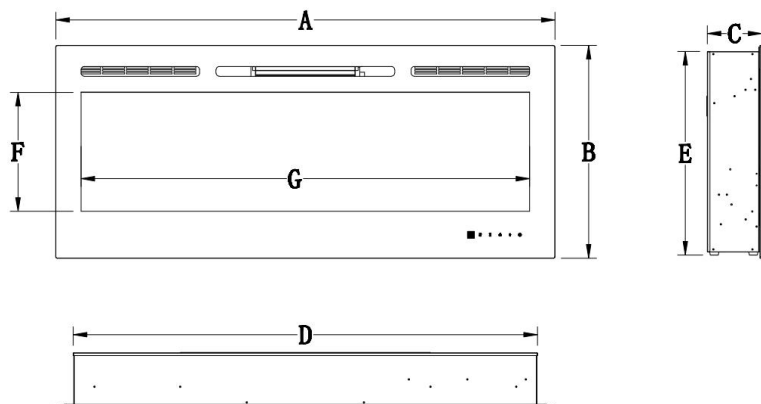

Description	Electric Fireplace
Type	3 Way Mounting Unit Wall-Mount, Recess into Wall and Assemble with mantel
Voltage	220V AC
Watts	MAX 1600W
Amps	10 AMP Grounded Circuit

PRODUCT DIMENSIONS

Model Number	A	B	C	D	E	F	G
VL-36B	36" 91.5cm	21.46" 54.4cm	5.51" 14cm	32.48" 82.5cm	20.51" 52.1cm	12" 30.5cm	30.91" 78.5cm
VL-45B	45" 114.3cm	21.46" 54.4cm	5.51" 14cm	39.88" 101.3cm	20.51" 52.1cm	12" 30.5cm	38.31" 97.3cm
VL-50B	50" 128cm	21.46" 54.4cm	5.51" 14cm	46.85" 119cm	20.51" 52.1cm	12" 30.5cm	45.28" 115cm
VL-55B	55" 139.7cm	21.46" 54.4cm	5.51" 14cm	46.85" 119cm	20.51" 52.1cm	12" 30.5cm	45.28" 115cm
VL-60B	60" 152.4cm	21.46" 54.4cm	5.51" 14cm	46.85" 119cm	20.51" 52.1cm	12" 30.5cm	45.28" 115cm
VL-65B	65" 165.1cm	21.46" 54.4cm	5.51" 14cm	61.5" 156.1cm	20.51" 52.1cm	12" 30.5cm	59.8" 152.1cm
VL-72B	72" 182.8cm	21.46" 54.4cm	5.51" 14cm	68.39" 173.72m	20.51" 52.1cm	12" 30.5cm	66.82" 169.72cm
VL-100B	100" 254cm	21.46" 54.4cm	5.51" 14cm	96.39" 244.83cm	20.51" 52.1cm	12" 30.5cm	94.8" 240.84cm

Installation and Assembly

Your appliance is a wall-mounted, recessed and/or mantel installed appliance. Select a suitable location that is not susceptible to moisture and is away from drapes, furniture and high traffic areas.

NOTE: Follow all National and local electrical codes.

MINIMUM CLEARANCE TO COMBUSTIBLES

Measurements are taken from the glass front.			
Bottom	0"	Top	8" (300mm) to mantel
Sides	0"	Top	8" (300mm) to ceiling
Back	0"		

MINIMUM MANTEL CLEARANCES

WARNING

WHEN USING PAINT OR LACQUER TO FINISH THE MANTEL, THE PAINT OR LACQUER MUST BE HEAT RESISTANT TO PREVENT DISCOLOURATION.

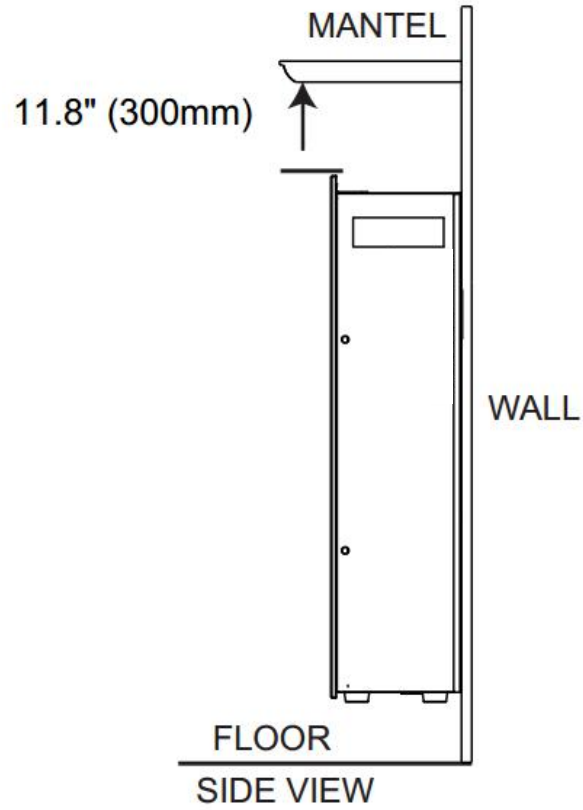

RECESSED TO WALL INSTALLATION

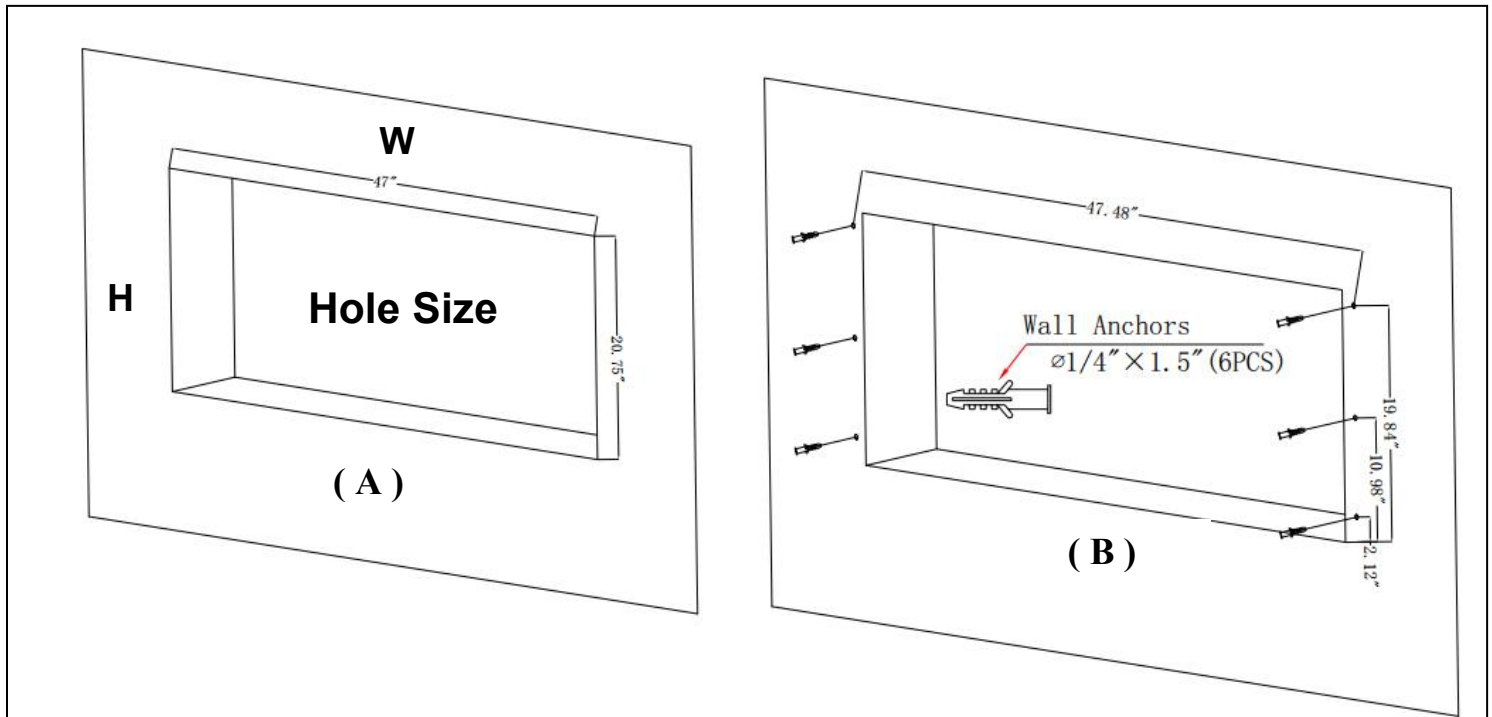

STEP A. Selection a dry wall to open a hole for fireplace box. Size of hole as below chart **Figure (A)**

Framing Hole Size		
Model Number	W	H
VL-36B	33" (83.82CM)	20.75" (52.71CM)
VL-45B	40" (101.6CM)	20.75" (52.71CM)
VL-50B	47" (119.38CM)	20.75" (52.71CM)
VL-55B	47" (119.38CM)	20.75" (52.71CM)
VL-60B	47" (119.38CM)	20.75" (52.71CM)
VL-65B	62" (157.48CM)	20.75" (52.71CM)
VL-72B	69" (175.26CM)	20.75" (52.71CM)
VL-100B	97" (246.38CM)	20.75" (52.71CM)

STEP B. Fix the three wall anchors in each side of the fireplace box according to the dimensions showed on the drawing. **Figure (B)**

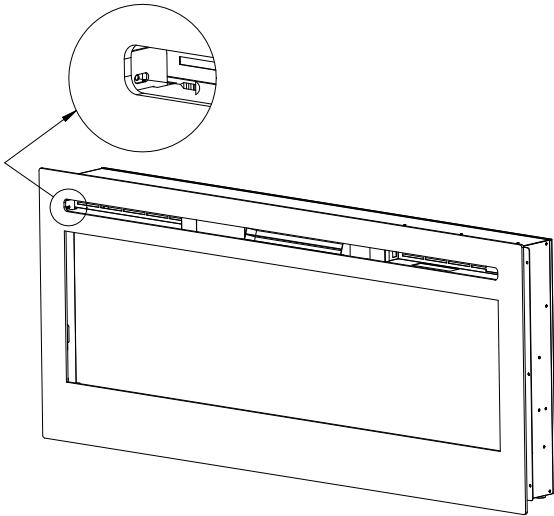

(C)

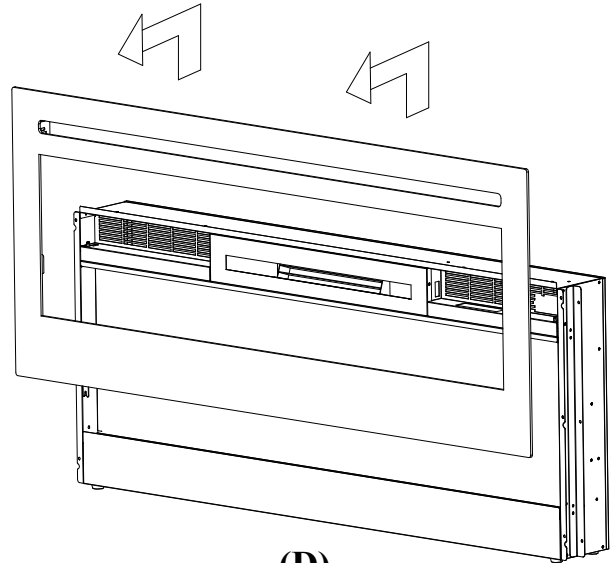

(D)

STEP C. Take off the two screws in both sides of the glass panel. **Figure (C)**

STEP D. Have two person to take the glass panel out of the fireplace box. Place it to a soft and clean place. **Figure (D)**

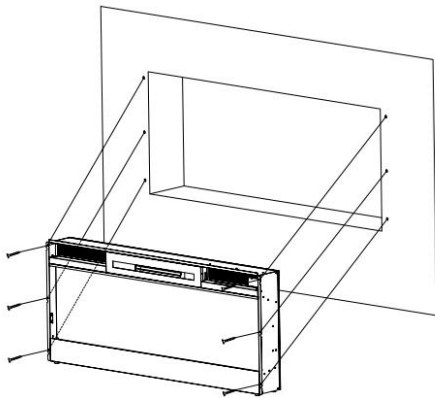

(E)

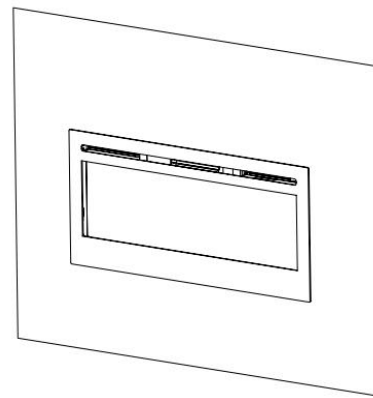

(F)

STEP E. Have two person to move the fireplace box to the wall hole.

If the appliance is fully recessed into the wall:

- Use the 6 screws (provided) to lock the appliance into the wall with the existing two side flanges, see **Figure (E)**
- Install the media and re-install the glass front.

STEP F. Fireplace will be like this after installation **Figure (F)**

Wall Mounted Installation

Due to the many different materials used on different walls, it is highly recommended that you consult your local builder before you install this appliance on the wall.

A. Select a location that is not prone to moisture and is located at least 36" (914mm) away from combustible materials such as curtain drapes, furniture, bedding, paper, etc.

B. Have two people hold the appliance against the wall to determine the final location.

C. Place unit face down on a soft, non abrasive surface. Remove the bracket from the back of the unit by removing the screws, refer to Figure 1.

D. Mark out location, then mount the bracket(s) onto the wall using the supplied screws. This bracket

MUST have the hooks facing upward and be level. **NOTE: It is strongly**

recommended that the mounting bracket (E) be Screwed into the wall studs Where possible. If the wall Studs cannot be used, ensure

That the supplied plastic anchors are used to affix the bracket to the wall and the bracket is adequately secured.

E. With the wall mounting bracket installed have two people lift the appliance up and insert the two hooks

on the bracket into the two slots on the back of the appliance.

F. Check the appliance for stability ensuring that the bracket will not pull free from the wall.

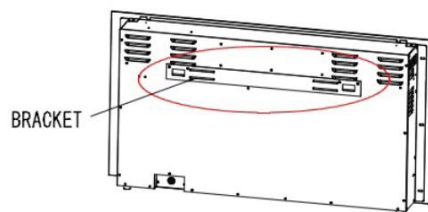
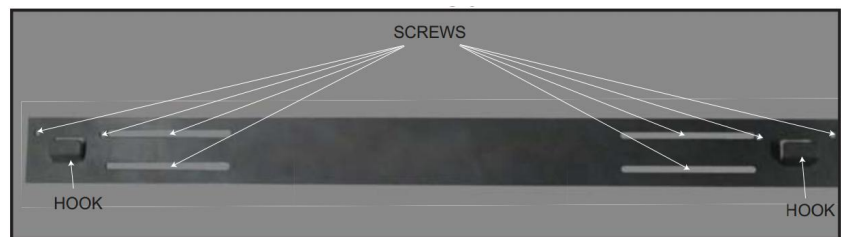
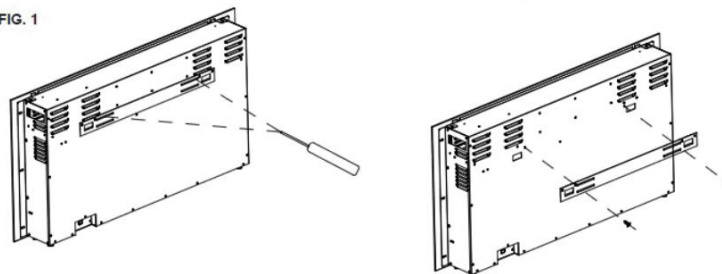
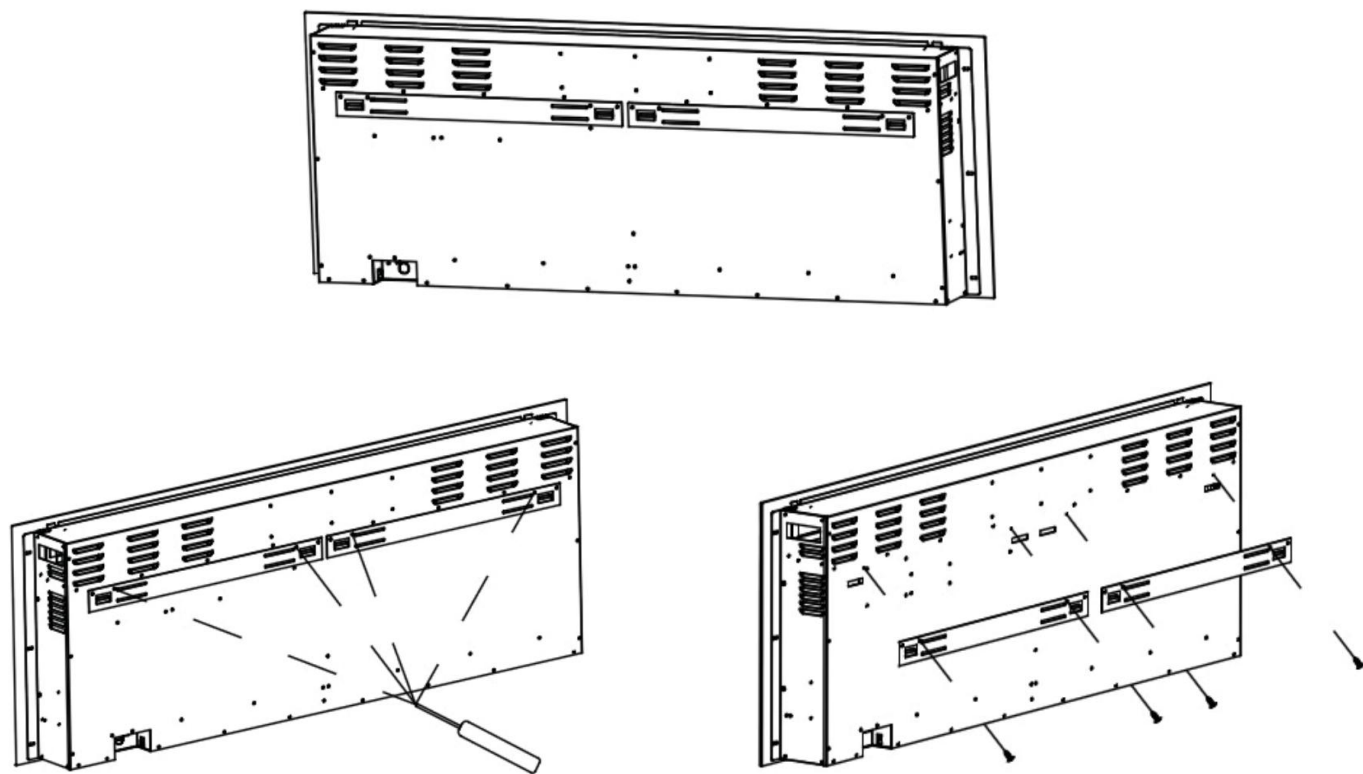

FIG. 1



VL-36/45/50/60B Wall Bracket Illustrated



VL-72/100B Wall Bracket Illustrated

Log set / Crystal / Pebble Ember Installation

(NOTE: Please make the installation according to the embers which you bought or selected.)

- A. Glass front must be removed and the appliance must be mounted in its final location before the log set / crystal / pebble embers are installed.
- B. If your fireplace come with log set, remove the log set from the package, put it to the fireplace designed place. **Figure 1.**
- C. If your fireplace come with CLEAN CRYSTAL or PEBBLE MEDIA: Crystal or pebbles media may have a fine oil residue that needs to be cleaned prior to installation. Clean the them with mild dish soap, drain, rinse thoroughly and dry before placing into the tray.
- D. Place the plastic tray (I) to the fireplace designed place. Then carefully place crystal or pebbles embers into the bottom tray on the front of the appliance as illustrated. Apply an even layer from side to side. **Figure 2, Figure 3.**

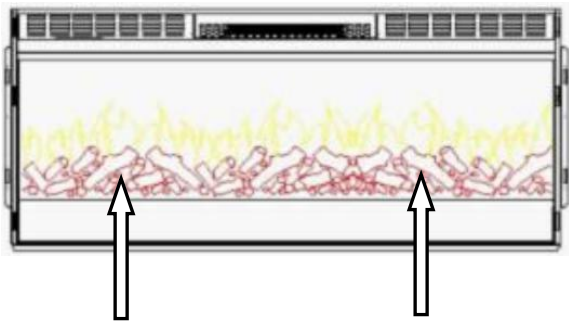

Figure 1.

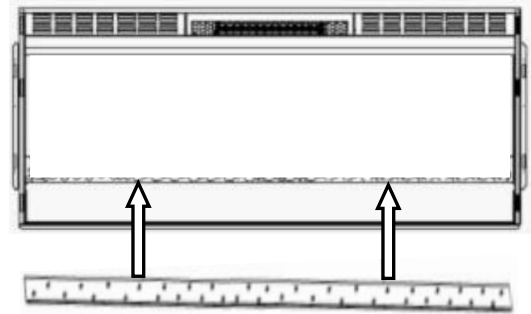

Figure 2.



Figure 3. (Crystal medias)



Figure 3. (Pebbles medias)

Operation



Read and understand this entire owner's manual, including **all safety information**, **before plugging in** or **using** this product. Failure to do so could result in **electric shock, fire, serious injury, or death.**

Power

Plug the power cord into a 220~240 Volt **10** Amp grounded outlet (see **IMPORTANT SAFETY INFORMATION** on **Pages 2 and 3**). Make sure the outlet is in good condition and that the plug is not loose. **NEVER** exceed the maximum amperage for the circuit. **DO NOT** plug other appliances into the same circuit.

Methods of Operation



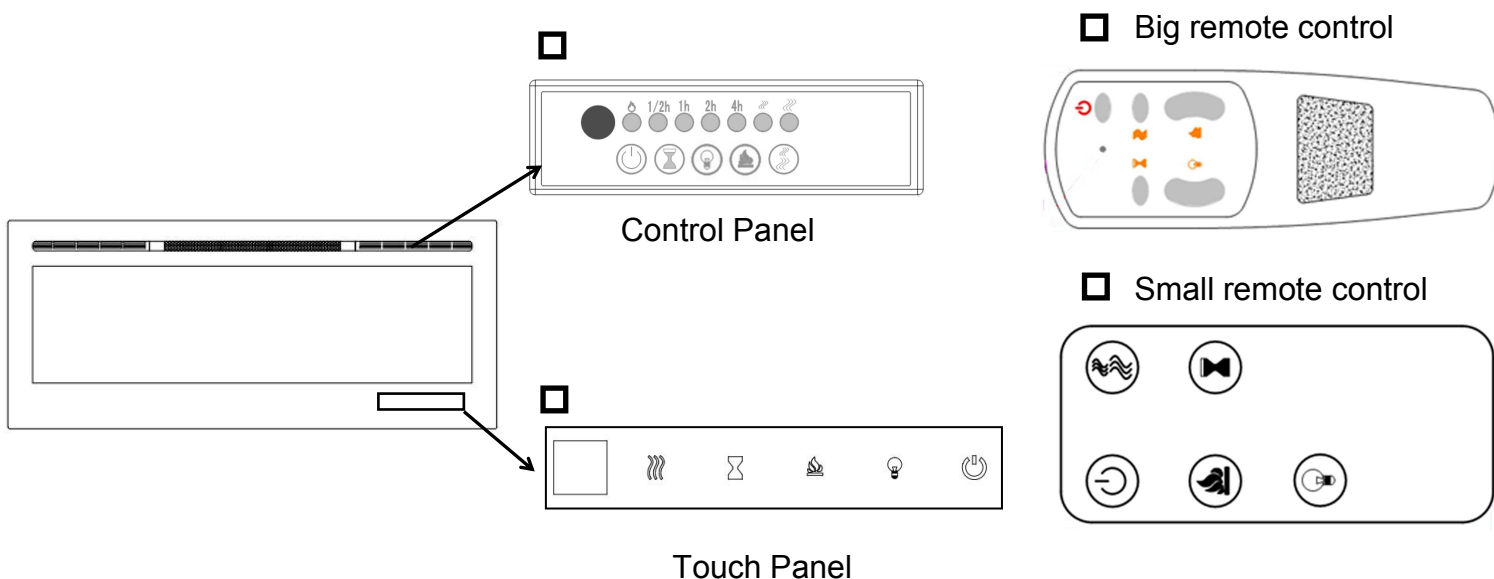

This electric fireplace can be operated by the CONTROL PANEL, located on the UP right side glass panel slot of the fireplace, or by the battery-powered REMOTE CONTROL.

The operation and functions of the two methods are the same.

Before operating, please review the **IMPORTANT SAFETY INFORMATION** on **Pages 2 and 3**, and heed all warnings.



Control Panel / Touch Panel / Remote Control Operation

BUTTON	FUNCTION	ACTION & INDICATION
 POWER	ON: Enables control panel functions and remote control. Turns on flame effect. OFF: Disables control panel functions and remote control. Turns off flame effect.	1. Press once. Indicator light turns on. Power turns on. All functions enabled. 2. Press again. Flame effect turns off. Unit goes to standby. All functions turn off.
 TIMER	TIMER button: Controls timer settings to turn off fireplace at selected time. Settings range from 0.5 hours to 7.5 hours.	1. Press once. Indicator light turns on. Timer is set to 0.5 hours. 2. Press again until desired setting is reached. Indicator lights show setting.
 FLAME	FLAME button: Makes flame effect dimmer and brighter. NOTE: Flame effect stays on until power button is turned off. Flame effect must be on for heater to turn on.	1. Press once. Flame brightness effect gets changing. 2. Press again. until desired setting is reached.
 COLOR	COLOR button: Makes the color flame effect changing. NOTE: color effect stays on until power button is turned off. Color flame effect must be on for heater to turn on. NOTE: this fireplace is with memory function for flame.	1. Press once. Flame color effect gets changing. 2. Press again until desired setting is reached.

 <p>HEATER</p>	<p>HEATER button: Turns heater on and off.</p> <p>NOTE: The heater only works when the flame effect is on. If the flame effect is off, the heater will not turn on.</p> <p>NOTE: To prevent overheating, the heater fan will blow cool air for 8-10 seconds before the heater turns on, and after the heater turns off.</p>	<ol style="list-style-type: none"> Press once. Indicator lights up. Fan blows cool air for 10 seconds. 750W heater turns on and blows warm air. Press again. Indicator lights up. 1500W heater turns on and blows hot air. Press again. Heaters turn off. The fan blows cool air for 10 seconds to allow heater to cool down, then turns off.
--	--	---

NOTICE When the heater is first turned on, a slight odor may be present. This is normal and should not occur again unless the heater is not used for a long period of time.

NOTICE To improve operation, **aim** the remote control at the front of the fireplace. **DO NOT press the buttons too quickly.** Give the unit time to respond to each command.

Temperature Limiting Control

This heater is equipped with a Temperature Limiting Control. Should the heater reach an unsafe temperature, the heater will automatically turn OFF. To reset:

1. Unplug the power cord from the outlet.
2. Turn the ON/OFF switch on the CONTROL PANEL to OFF. **Wait 5 minutes.**
3. Inspect the fireplace to make sure no vents are blocked, or clogged with dust or lint. If they are, use a vacuum to clean the vent areas.
4. With the POWER switch in the OFF position, plug the power cord back into the outlet.
5. If the problem continues, have your outlet and wiring inspected by a professional.

Remote Control Battery Information

- Small remote control uses one **CR2025** battery (**Included**)
- Big remote control uses two **AAA** batteries (**Not Included**)

NOTE: Remote control battery used depends on the remote control type which selected above.

 **NEVER** dispose of batteries in **fire**. Failure to observe this precaution **may result in an explosion**. Dispose of batteries at your local hazardous material processing center.

Care and Maintenance

Cleaning

 **ALWAYS** turn the heater **OFF** and **unplug the power cord from the outlet** before cleaning, performing maintenance, or moving this fireplace. Failure to do so could result in **electric shock, fire, or personal injury**.

 **NEVER** immerse in **water** or **spray with water**. Doing so could result in **electric shock, fire, or personal injury**.

Metal:

- Buff using a soft cloth, slightly dampened with a citrus oil-based product.
- **DO NOT** use brass polish or household cleaners as these products will damage the metal trim.

Glass:

- Use a good quality glass cleaner sprayed onto the cloth or towel. Dry thoroughly with a paper towel or lint-free cloth.
- **NEVER** use abrasive cleansers, liquid sprays, or any cleaner that could scratch the surface.

Vents:

- Use a vacuum or duster to remove dust and dirt from the heater and vent areas.

Plastic:

- Wipe gently with a slightly damp cloth and a mild solution of dish soap and warm water.
- **NEVER** use abrasive cleansers, liquid sprays, or any cleaner that could scratch the surface.

Maintenance



Risk of electric shock! DO NOT OPEN any panels ! No user-serviceable parts inside!



ALWAYS turn the heater **OFF** and **unplug the power cord from the outlet** before cleaning, performing maintenance, or moving this fireplace. Failure to do so could result in **electric shock, fire, or personal injury.**

Electrical and Moving Parts:

- The fan motors are lubricated at the factory and will not require lubrication.
- Electrical components are integrated in the fireplace and are not serviceable by the consumer.

Storage:

- Store heater in a clean dry place when not in use.



WARNING! NO SERVICING of the internal or electrical parts should be performed by the consumer. Do not service the unit yourself.

**VisionLine
444 Swan Street
Richmond,
Victoria
3121
Australia**

**Phone :- 1300 219 875 or 9429 5573
email :- info@visionlinefire.com.au**