



# TAURUS DS

Zero clearance  
Low emission burner

## INSTALLATION AND OWNERS MANUAL

**INSTALLER:** Leave this manual with party responsible for use and operation

**OWNER:** Retain this manual for future reference

Contact your dealer with questions on installation, operation or service

## Australian Compliance tag - sample

### WOODFIRE COMPLIANCE LABEL

This appliance has been TESTED TO AS/NZS4012/4013 for Hardwood by ASFT Report. 23020 Date tested: MARCH 2023

---

**VisionLINE Taurus DS**

OVERALL AVERAGE EFFICIENCY

WHEN TESTED IN ACCORDANCE WITH AS/NZS 4014.1: 62%

AVERAGE PARTICULATE EMISSION FACTOR

WHEN TESTED IN ACCORDANCE WITH AS/NZS 4014.1: 0,8 G/KG

MAXIMUM AVERAGE HEAT OUTPUT 13.1 kW

CATALYTIC COMBUSTOR NO

APPROVED FUEL: BURN ONLY HARDWOOD WITH A MOISTURE CONTENT LESS THEN 20%

Wetback - All Models: Wetbacks are NOT an approved option and must not be fitted.

Manufactured By: Burning Technology - Stupkova - 952/18, Nová Ulice, 77900, Olomouc - Czech Republic EU

Date of Manufacture / Date de fabrication: 7038-200 R4

Serial No./ N° de série: BT 011A 001 5 7251 B

2023 2024 2025 JAN FEB MAR APR MAY JUN JUL AUG SEP OCT NOV DEC

---

Made in The EU

INSTALLATION DATE:    /    /

For Australia, 1x 575mm x 100mm x 30mm baffle brick must be removed and the remaining 200mm baffle brick must be centrally located on the provided bracket. For baffle and firebrick removal, see page 20.

## New Zealand Compliance tag - sample

### WOODFIRE COMPLIANCE LABEL

This appliance has been TESTED TO AS/NZS4012/13 for Softwood by ASFT Report. 24009 Date tested: JANUARY 2024

---

**VisionLINE Taurus DS**

OVERALL AVERAGE EFFICIENCY

WHEN TESTED IN ACCORDANCE WITH AS/NZS 4012: 66%

AVERAGE PARTICULATE EMISSION FACTOR

WHEN TESTED IN ACCORDANCE WITH AS/NZS 4013: 0,8 G/KG

MAXIMUM AVERAGE HEAT OUTPUT 11,9 kW

RANGE OF AVERAGE HEAT OUTPUT 9,1 - 15,6 kW

APPROVED FUEL: BURN ONLY SOFTWOOD WITH A MOISTURE CONTENT LESS THEN 20%

EMISSION AVERAGE RATE 55,36 mg/MJ

Manufactured By: Burning Technology - Stupkova - 952/18, Nová Ulice, 77900, Olomouc - Czech Republic EU

**Inbuild**

Date of Manufacture / Date de fabrication: 7038-200 R4

Serial No./ N° de série: BT 011A 001 5 5893 B

2023 2024 2025 JAN FEB MAR APR MAY JUN JUL AUG SEP OCT NOV DEC

---

ECAN number:

Made in The EU

INSTALLATION DATE:    /    /

Performance may vary from test

For insert or zero clearance installations, the compliance tag must be secured to the unit with the supplied wire and positioned under the firebox for future access.

Safety Alert Key:



- **DANGER!** Indicates a hazardous situation which, if not avoided will result in death or serious injury.
- **WARNING!** Indicates a hazardous situation which, if not avoided could result in death or serious injury.
- **CAUTION!** Indicates a hazardous situation which, if not avoided, could result in minor or moderate injury.
- **NOTICE:** Indicates practices which may cause damage to the appliance or to property.

Table of Contents

1. Sample of Serial Number / Safety Label	13. Zero Clearance Assembly
2. Table Of Contents	16. Fan assembly
3. Appliance Dimensions	18. Flue system
4. General Information	20. Wiring Diagram
5. Hearth and Clearance provisions	21. Fireplace operation
7. Timber Frame and Finishing guide	22. Cleaning & Inspection
9. Install Checklist	23. Firebrick Removal
10. Install Guide	25. Seismic Restraint
12. 2918 General Notes	27. Warranty Information



**WARNING**



**Fire Risk.**  
VisionLINE fireplaces disclaims any responsibility for, and the warranty will be voided by, the following actions:

- Installation and use of any damaged appliance.
- Modification of the appliance.
- Installation other than as instructed by VisionLINE fireplaces.
- Installation and/or use of any component part not approved by VisionLINE fireplaces.
- Operating appliance without fully assembling all components.
- Do NOT Over fire - If appliance or chimney connector glows, you are over firing.

**Any such action that may cause a fire hazard.**



**WARNING**



**If the information in these instructions is not followed exactly, a fire could result causing property damage, personal injury, or death.**

- Do not store or use gasoline or other flammable vapors and liquids in the vicinity of this or any other appliance.
- Do not over fire - If appliance or chimney connector glows, you are over firing. Over firing will void your warranty.
- Comply with all minimum clearances to combustibles as specified. Failure to comply may cause house fire.

## ZERO CLEARANCE CASE

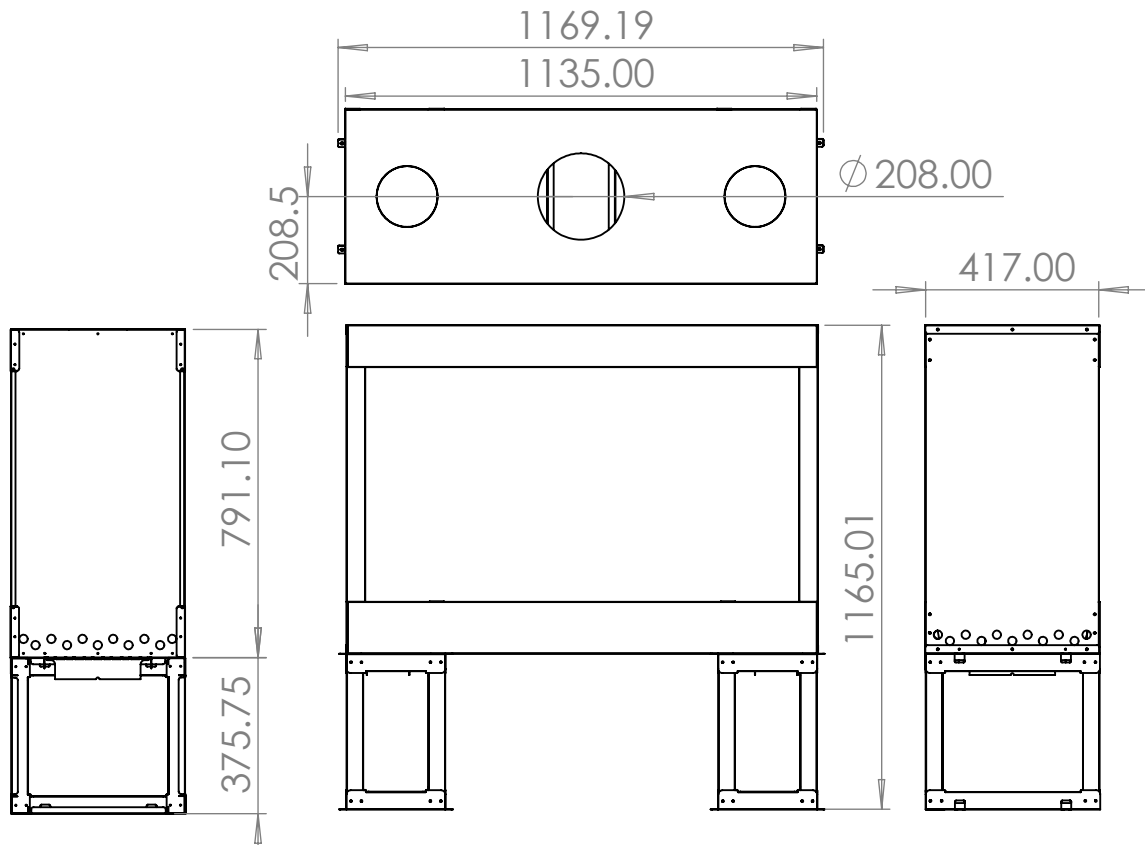

If installation includes the dual fan system, provision must be included for access to be able to service them from below the zero clearance case.

This can be either an access panel on at least one facing side or both left and right sides.

More information on the optional fans can be found on page 16

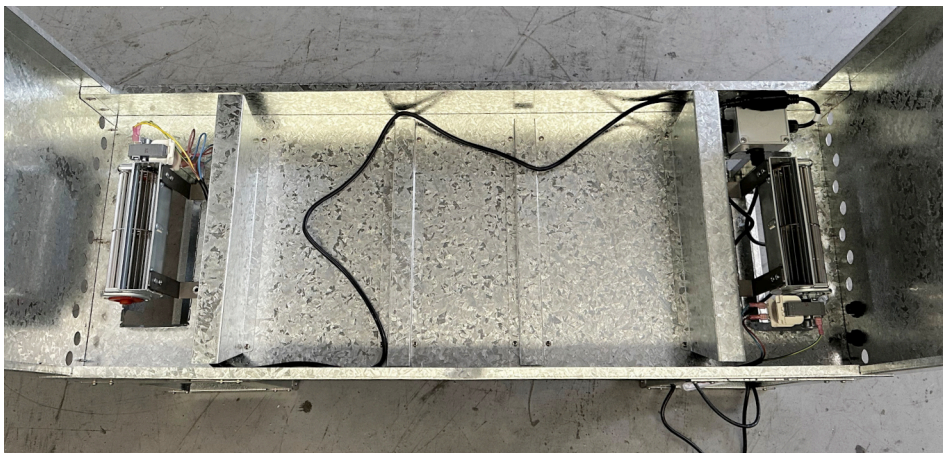

**IMPORTANT:** Read all instructions carefully before starting installation. Failure to follow these instructions may result in a fire hazard and will void the warranty.

INSTALLATIONS TO COMPLY WITH AS/NZS2918 AND MAY REQUIRE A BUILDING CONSENT

**Please note:** the burn rate control handle for this fireplace is on one side only. When considering the installation, consult the home owner to ensure the burn rate control is on the preferred side as this **cannot be** altered without rotating the firebox.



**WARNING**



**Fire Risk.**  
For use with solid wood fuel only.  
Other fuels may over fire and generate poisonous gases (i.e. carbon monoxide).

For a floating hearth, consideration should be given to the usability of the burn rate control handle due to the low position location. See example below

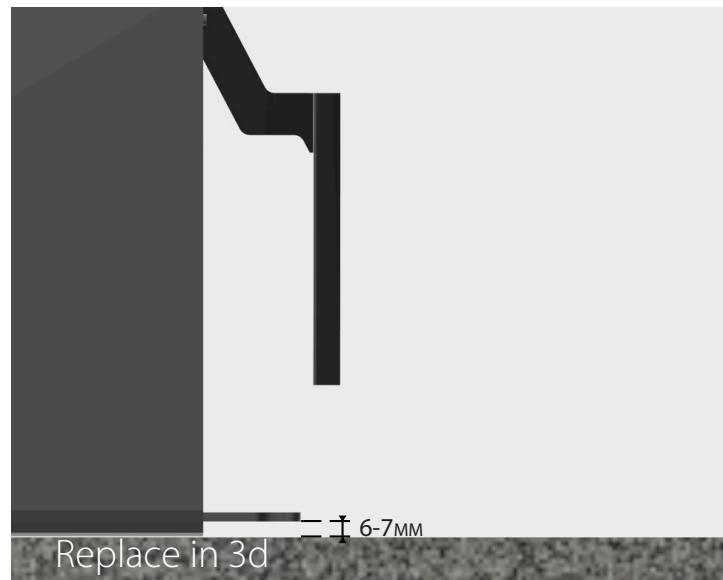

**Note:**

- The Taurus DS firebox weighs approx. 220kg.
- To safely lift the unit onto the base for positioning, the unit should be stripped of as much weight as possible by removing all bricks, baffles and the door assemblies.
- Page 23 & 24 contains information regarding brick removal and re-assembly.
- The top door hinge should be marked for its location prior to removal so it can be re-assembled easily into its correct location. If the door doesn't locate into the latch mechanism correctly adjustment is via the two bolts on the top hinge. Refer to page 25.

FAN PROVISIONS

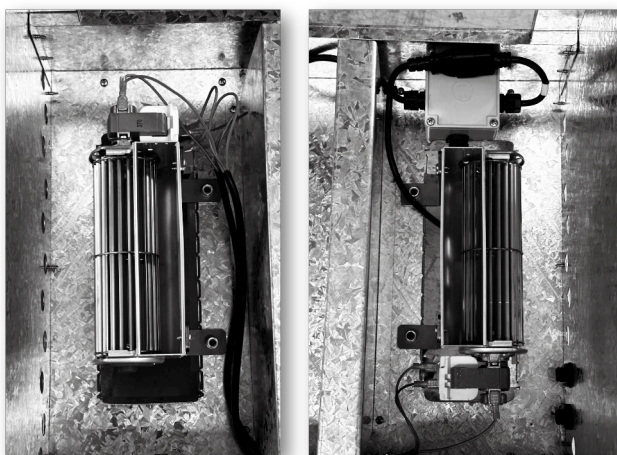

If installing the optional dual fan system, ensure there is provision for power. Power cord requires a single 240v 10amp GPO.

Access for fans for servicing/cleaning is via underneath the zero clearance case and either an access panel on at least one facing side or 2x access panels on the shorter sides must be provided. Four supplied m6 bolts hold the fan brackets in place for removal.



**Notice:** If fan servicing access point is used for storing wood, take note to leave the vents on the sides clear for optimum air flow.



OUTSIDE AIR

The Taurus DS can be connected to outside air via the central air intake at the base of the unit. This can be via rigid or flexible connection to a vermin proof cap on the exterior of the building.

Due to the location of this outside air connection, the requirement to utilise this would be to remove the knockout point in the base, and zero clearance case and either drill through the hearth and sub floor to create the connection to outside or run inside the cavity and terminate at the roof with a breather vent.

*Please note: The outside air duct must be led outdoors or into a well-ventilated room inside the building (cellar, utility room, etc.).*

# CLEARANCE REQUIREMENTS

A minimum 440mm deep x 1040mm wide x 6mm thick floor protector (compressed board) should be used under the appliance, a minimum 1240mm wide x 300mm deep x 6mm thick floor protector (compressed board) must be used in front of the enclosure base front and rear walls when installing the appliance (see joint AS/NZS 2918:2018 3.3.2).

The floor protector should extend 300mm in front of the front and rear walls of the enclosure and be placed centrally in the 1240mm width.

The appliance and Flue Combination should be installed at the following clearances:

- Venting in the ceiling of the enclosure around the outer triple skin flue must be a minimum of 210,405mm<sup>2</sup> evenly spaced around the outer flue casing.
- Timber framing in the ceiling cavity must be a minimum of 1225mm above the zero box and must not restrict the 210,405mm<sup>2</sup> air flow around the flue casing. The outer casing of the flue (10") must be raised 65mm above the zero clearance box.
- The inner galvanised casing of the flue (8") must be vented into the zero clearance box outer skin and be sealed to prevent venting into the enclosure. Underside of the mantelshelf shall be no closer than 385mm from the top of the appliance hot air outlet, the mantel shelf shall extend no further than 250mm into the room.
- Underside mantelshelf key shall be no closer than 335mm from the top of the appliance hot air outlet, the mantle key shall extend no further than 25mm into the room.
- The front wall of the enclosure must be made of non-combustible material to a height of 1505mm high above the floor protector and must extend to 100mm either side of the zero box.
- First internal noggins must be a minimum of 300mm above top of zero clearance box. The Noggin must not be closer than 30mm from the outer flue casing.
- The Zero clearance box as tested must have an air gap of 7mm above the Taurus appliance and the zero clearance box.
- Combustible material/side walls of the enclosure must be a minimum of 100mm from each side of the appliance zero clearance box.

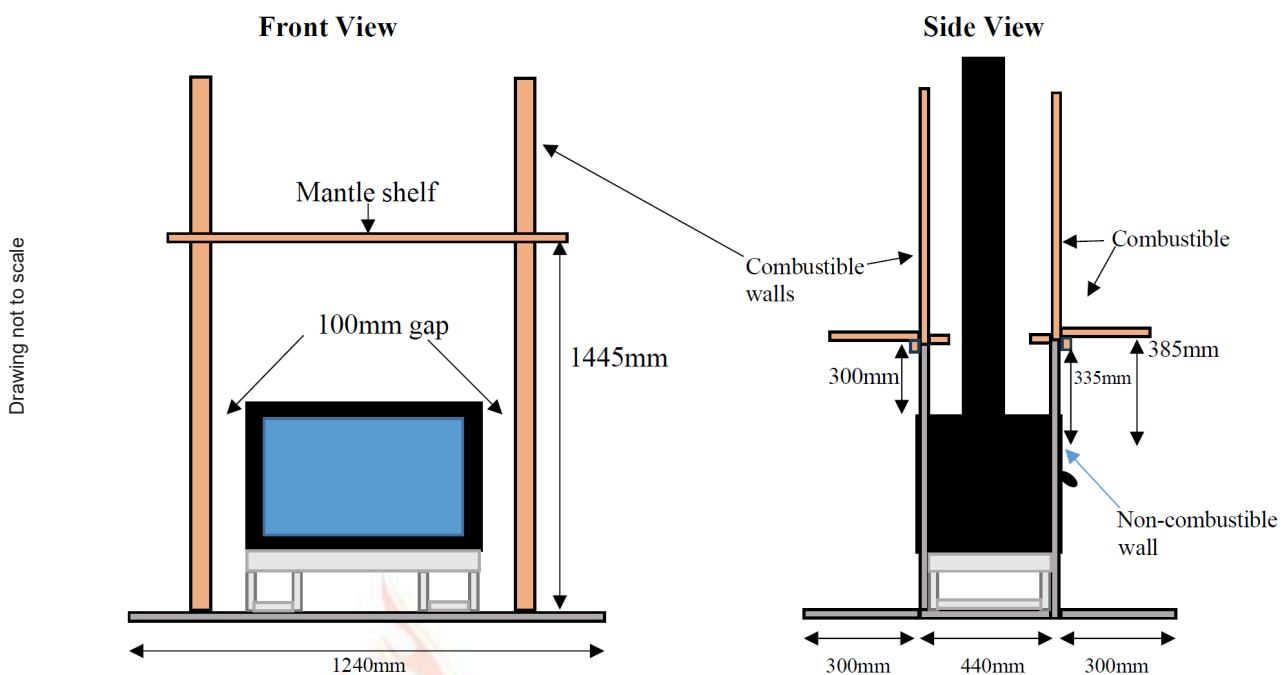

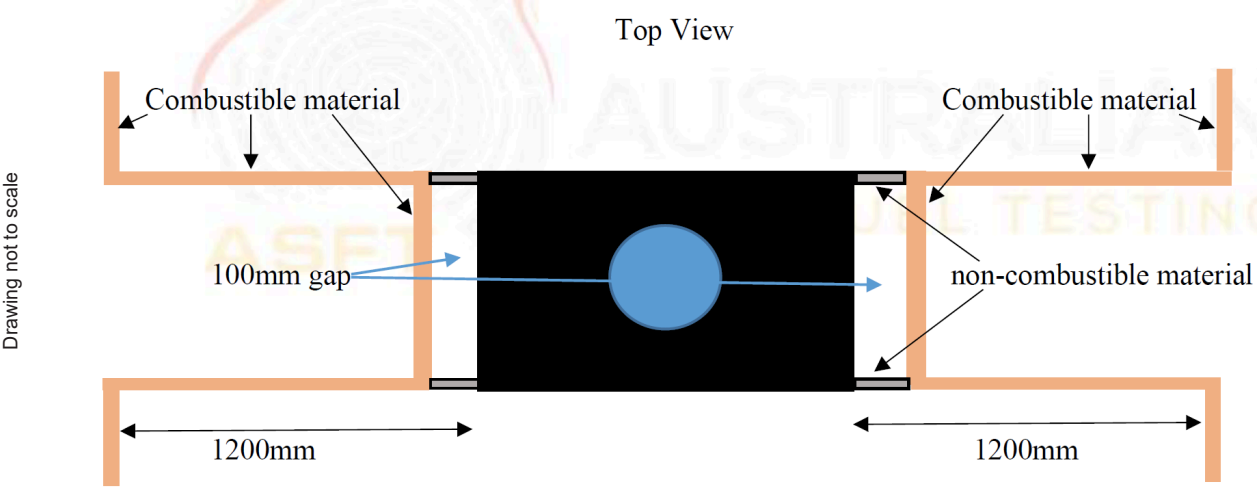

TIMBER FRAMING

Front elevation

Frame opening of 1480mm high x 1340mm wide and 425mm deep

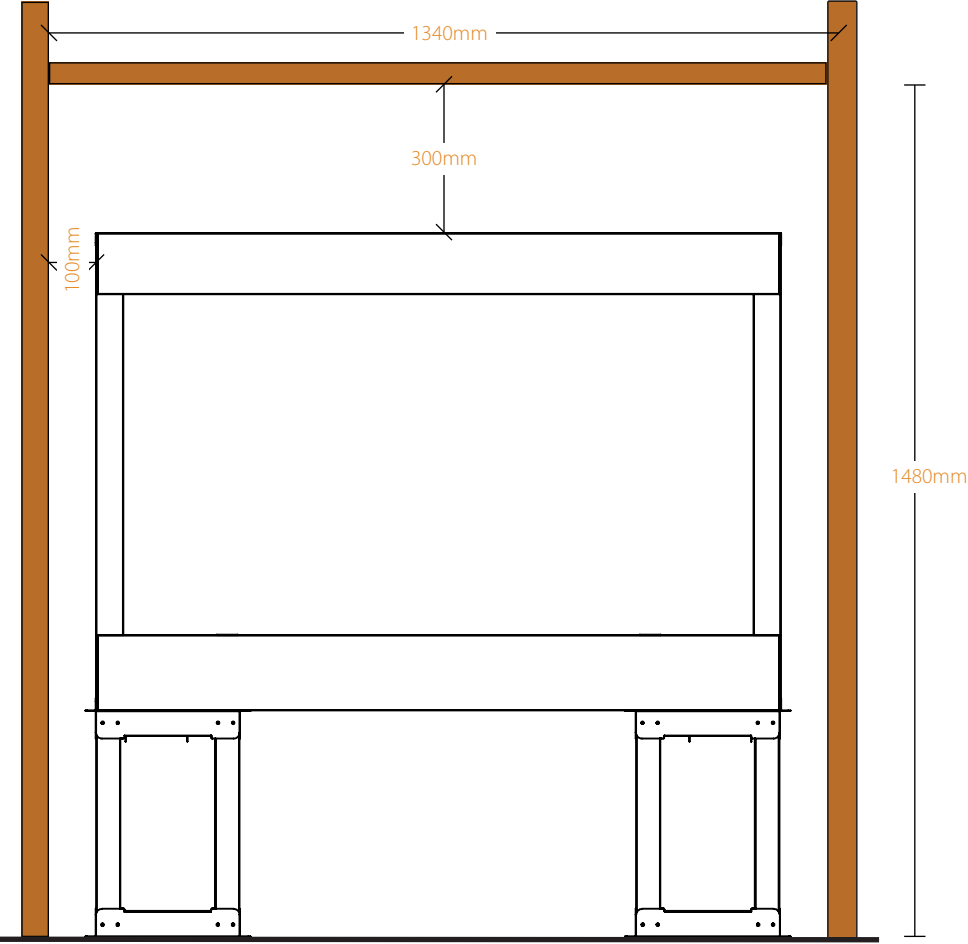

TIMBER FRAMING AND FINISHING

Side Elevation

Frame opening of 1480mm high x 1340mm wide and 425mm deep

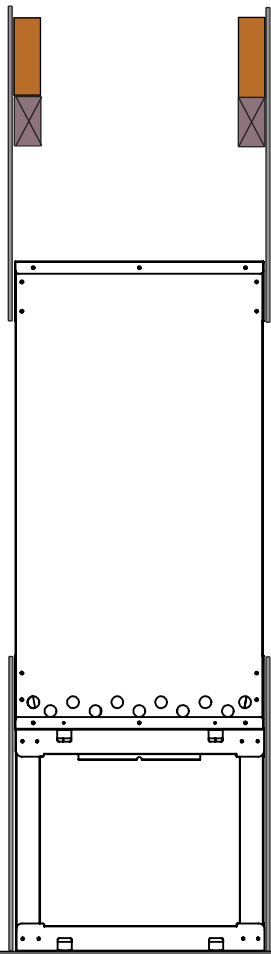

Fix wall cladding to header and studs above the unit do not fix or glue wall sheeting to fireplace.

300mm clearance required from unit to header. No combustible materials permitted in this area.

Minimum 9mm CFC sheeting or similar non-combustible material for wall facing.

Series 1 removeable handle units: Do not exceed 20mm finishing material over the face of the zero clearance case. For finishing materials exceeding a 20mm depth, use the optional 50mm surround as a shadow line and finish thicker materials outside of it. Tile edge (not provided) may be desired.

Please Note - Light coloured wall paints may discolour over time due to heat darker colours are recommended if the fireplace wall is to be a painted finish

If using the dual fans, consideration must be given on access for servicing either via creating wood storage below the unit on at least one side or integrating removable vents for each fan.

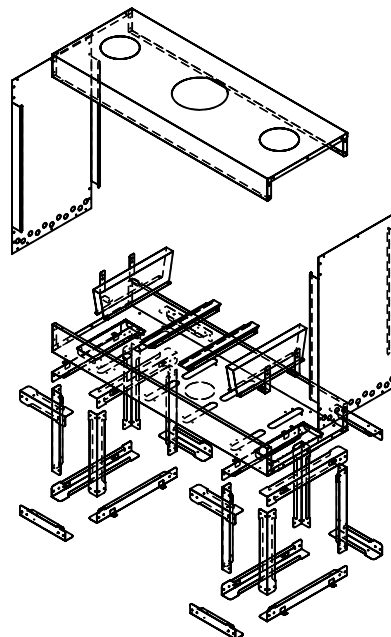
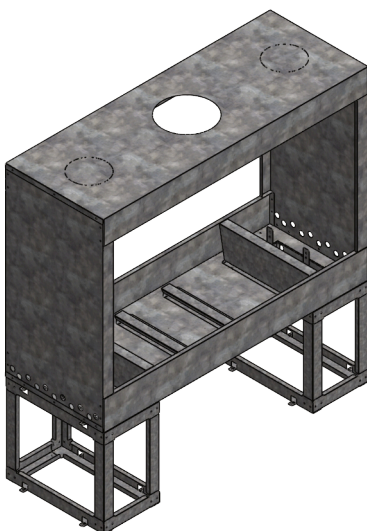

**Component list for ZC casing**

- 1x bag of self tapping screws
- 1x top panel
- 2x side panels
- 1x base panel
- 2x large support rails
- 4x fan brackets (with riv-nuts fitted)
- 2x thin ventilation covers (case base)

**Component list for base**

- 8x long rails
- 8x upright support rails
- 8x short horizontal rails



Wall Cladding to be minimum 9mm CFC sheeting or similar non-combustible material.

DO NOT overlap the 6mm firebox. Only cover the zero clearance casing with finishing material and leave a 3-5mm gap to the firebox.

Series 1 removeable handle units: Do not exceed 20mm finishing material over the face of the zero clearance case. For finishing materials exceeding a 20mm depth, use the optional 50mm surround as a shadow line and finish thicker materials outside of it. Tile edge (not provided) may be desired.

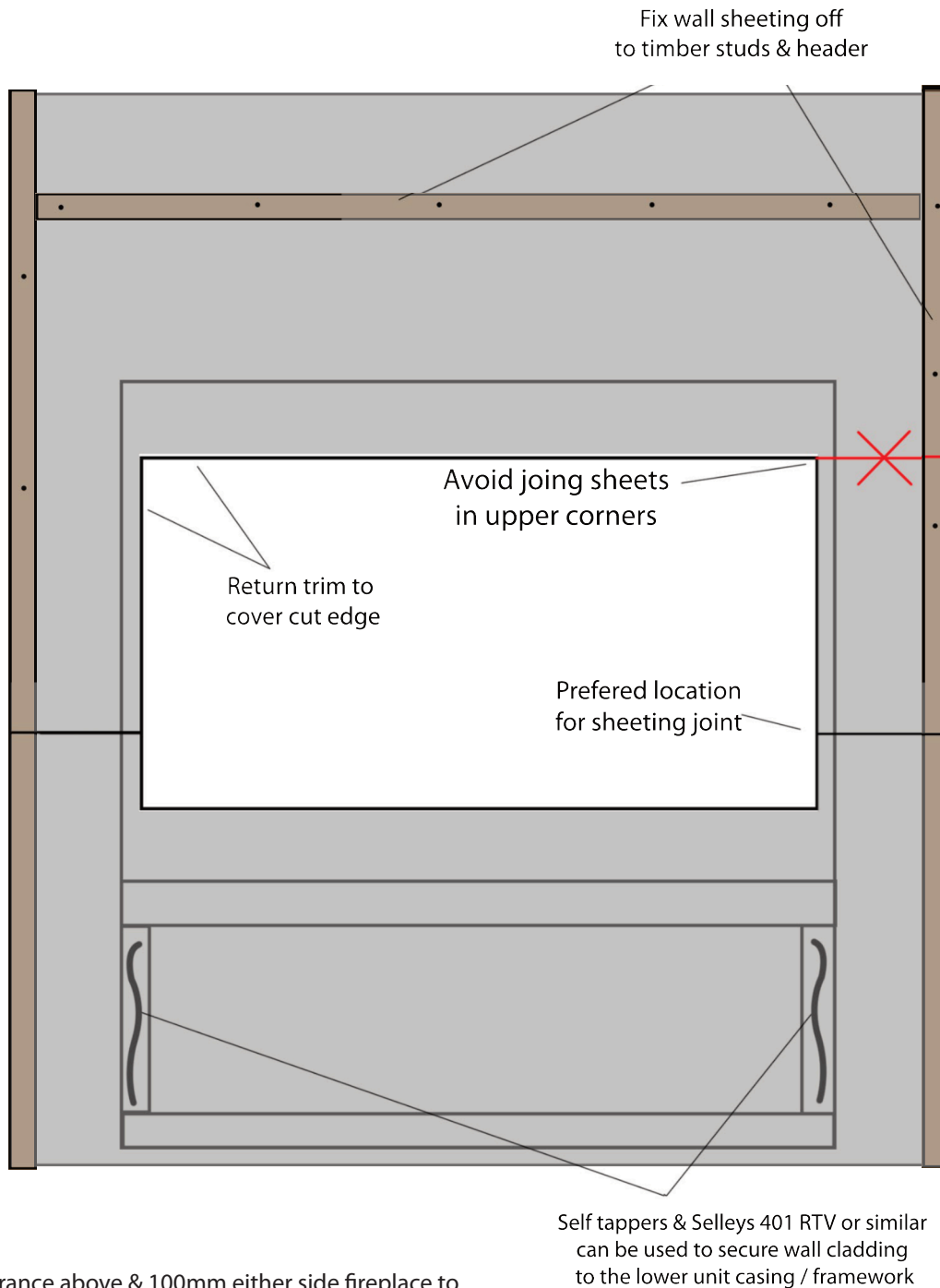

300mm clearance above & 100mm either side fireplace to combustible materials

Please Note - Light coloured painted wall finishes may discolour due to heat

Darker colours recommended if a painted finished is required.

**F. Install Checklist**

**ATTENTION INSTALLER**  
Follow this Standard Work Checklist

This standard work checklist is to be used by the installer in conjunction with, not instead of, the instructions contained in this installation manual.

Customer: \_\_\_\_\_  
 Date Installed: Lot / Address: \_\_\_\_\_  
 Location of Appliance: Installer: \_\_\_\_\_  
 Dealer / Distributor Phone #: Serial #: \_\_\_\_\_  
 Model: \_\_\_\_\_

**WARNING! Risk of Fire or Explosion!** Failure to install appliance according to these instructions can lead to a fire or explosion.

**Appliance Install**

	YES	IF NO, WHY?
Verified clearances to combustibles.	<input type="checkbox"/>	_____
Appliance is leveled and connector is secured to appliance.	<input type="checkbox"/>	_____
Hearth extension size/height decided.	<input type="checkbox"/>	_____
Outside air kit installed.	<input type="checkbox"/>	_____
Floor protection requirements have been met.	<input type="checkbox"/>	_____
If appliance is connected to a masonry chimney, it should be cleaned and inspected by a professional. If installed to a factory built metal chimney, the chimney must be installed according to the manufacturer's instructions and clearances.	<input type="checkbox"/>	_____

**Chimney**

Chimney configuration complies with diagrams.	<input type="checkbox"/>	_____
Chimney installed, locked and secured in place with proper clearance.	<input type="checkbox"/>	_____
Chimney meets recommended height requirements (14-16 feet). Roof flashing installed and sealed.	<input type="checkbox"/>	_____
Terminations installed and sealed.	<input type="checkbox"/>	_____

**Clearances**

Combustible materials not installed in non-combustible areas.	<input type="checkbox"/>	_____
Verified all clearances meet installation manual requirements.	<input type="checkbox"/>	_____
Mantels and wall projections comply with installation manual requirements.	<input type="checkbox"/>	_____
Protective hearth strips and hearth extension installed per manual requirements.	<input type="checkbox"/>	_____

**Appliance Setup**

All packaging and protective materials removed.	<input type="checkbox"/>	_____
Firebrick, baffle and ceramic blanket installed correctly.	<input type="checkbox"/>	_____
All labels have been removed from the door.	<input type="checkbox"/>	_____
All packaging materials are removed from inside/under the appliance.	<input type="checkbox"/>	_____
Manual bag and all of its contents are removed from inside/under the appliance and given to the party responsible for use and operation.	<input type="checkbox"/>	_____

VisionLINE fireplaces recommends the following:

- Photographing the installation and copying this checklist for your file.
- That this checklist remain visible at all times on the appliance until the installation is complete.

Comments: Further description of the issues, who is responsible (Installer/Builder/Other Trades, etc.) and corrective action needed:  
 Comments communicated to party responsible \_\_\_\_\_ by \_\_\_\_\_ on \_\_\_\_\_  
 (Builder / Gen. Contractor) (Installer) (Date)

## Getting Started

### A. Design and Installation Considerations

Consideration must be given to:

- Safety
- Convenience
- Traffic flow
- Chimney and chimney connector required

It is a good idea to plan your installation on paper, using exact measurements for clearances and floor protection, before actually beginning the installation. If you are not using an existing chimney, place the appliance where there will be a clear passage for a factory-built listed chimney through the ceiling and roof.

We recommend that a qualified building inspector and your insurance company representative review your plans before and after installation.

If this appliance is in an area where children may be near it is recommended that you purchase a decorative barrier to go in front of the appliance. Remember to always keep children away while it is operating and do not let anyone operate this appliance unless they are familiar with these operating instructions.

<b>CAUTION</b>	
	<p>Check building codes prior to installation.</p> <ul style="list-style-type: none"> <li>• Installation <b>MUST</b> comply with local, regional, state and national codes and regulations.</li> <li>• Consult insurance carrier, local building, fire officials or authorities having jurisdiction about restrictions, installation inspection, and permits.</li> </ul>

<b>WARNING</b>	
	<p><b>Asphyxiation Risk.</b></p> <ul style="list-style-type: none"> <li>• Do <b>NOT</b> connect this appliance to a chimney flue servicing another appliance.</li> <li>• Do <b>NOT</b> connect to any air distribution duct or system.</li> </ul> <p>May allow flue gases to enter the house.</p>

<p><b>NOTICE:</b> VISIONLINE FIREPLACES ASSUMES NO RESPONSIBILITY FOR THE IMPROPER PERFORMANCE OF THE APPLIANCE SYSTEM CAUSED BY:</p> <ul style="list-style-type: none"> <li>• Inadequate draft due to environmental conditions</li> <li>• Down drafts</li> <li>• Tight sealing construction of the structure</li> <li>• Mechanical exhausting devices</li> <li>• Over drafting caused by excessive chimney heights</li> <li>• Ideal performance is with height of chimney between 14-16 feet (4.26-4.88m) measured from the base of the appliance.</li> </ul>
--

### B. Fire Safety

To provide reasonable fire safety, the following should be given serious consideration:

1. Install at least one smoke detector on each floor of your home to ensure your safety. They should be located away from the heating appliance and close to the sleeping areas. Follow the smoke detector manufacturer's placement and installation instructions, and be sure to maintain regularly.
2. A conveniently located Class A fire extinguisher to contend with small fires resulting from burning embers.
3. A CO detector should be installed in the room with the appliance.
4. A practiced evacuation plan, consisting of at least two escape routes.
5. A plan to deal with a chimney fire as follows:  
In the event of a chimney fire:
  - a. Evacuate the house immediately
  - b. Notify fire department.

### C. Negative Pressure

<b>WARNING</b>	
	<p><b>Asphyxiation Risk.</b></p> <ul style="list-style-type: none"> <li>• Negative pressure can cause spillage of combustion fumes, soot and carbon monoxide.</li> <li>• Appliance needs to draft properly for safety.</li> </ul>

Negative pressure results from the imbalance of air available for the appliance to operate properly. It can be strongest in lower levels of the house.

Causes include:

- Exhaust fans (kitchen, bath, etc.)
- Range hoods
- Combustion air requirements for furnaces, water appliances and other combustion appliances
- Clothes dryers
- Location of return-air vents to furnace or air conditioning
- Imbalances of the HVAC air handling system
- Upper level air leaks such as:
  - Recessed lighting
  - Attic hatch
  - Duct leaks

To minimize the effects of negative air pressure:

- Install optional outside air kit with the intake facing prevailing winds during the heating season
- Ensure adequate outdoor air for all combustion appliances and exhaust equipment
- Ensure furnace and air conditioning return vents are not located in the immediate vicinity of the appliance
- Avoid installing the appliance near doors, walkways or small isolated spaces
- Recessed lighting should be a “sealed can” design
- Attic hatches weather stripped or sealed
- Attic mounted duct work and air handler joints and seams taped or sealed
- Basement installations should be avoided

**! WARNING**



**Fire Risk.**

VisionLINE fireplaces disclaims any responsibility for, and the warranty will be voided by, the following actions:

- Installation and use of any damaged appliance.
- Modification of the appliance.
- Installation other than as instructed by VisionLINE fireplaces.
- Installation and/or use of any component part not approved by VisionLINE fireplaces.
- Operating appliance without fully assembling all components.
- Operating appliance without legs attached (if supplied with appliance).
- Do NOT Over fire - If appliance or chimney connector glows, you are over firing.

Any such action that may cause a fire hazard.

**! WARNING**



**Fire Risk.**

Inspect appliance and components for damage. Damaged parts may impair safe operation.

- Do NOT install damaged components.
- Do NOT install incomplete components.
- Do NOT install substitute components.

Report damaged parts to dealer.

**D. Tools And Supplies Needed**

Before beginning the installation be sure the following tools and building supplies are available:

- |                             |                         |
|-----------------------------|-------------------------|
| Reciprocating saw           | Flat blade screwdriver  |
| Framing material            | Pliers                  |
| High temp caulking material | Electric drill and bits |
| Hammer                      | Plumb line              |
| Gloves                      | Safety glasses          |
| Phillips screwdriver        | Level                   |
| Framing square              | Tape measure            |
|                             | Misc. screws and nails  |
|                             | 10mm socket or wrench   |

1/2-3/4 in. length, #6 or #8 self-drilling screws

**E. Inspection of Appliance and Components**

- Remove appliance and components from packaging and inspect for damage.
- Report to your dealer any parts damaged in shipment.
- **Read all the instructions before starting the installation. Follow these instructions carefully during the installation to ensure maximum safety and benefit.**

**WARNING: THE APPLIANCE AND FLUE SYSTEM SHALL BE INSTALLED IN ACCORDANCE WITH AS/NZS 2918 AND THE APPROPRIATE REQUIREMENTS OF THE RELEVANT BUILDING CODE OR CODES.**

**WARNING: APPLIANCES INSTALLED IN ACCORDANCE WITH THIS STANDARD SHALL COMPLY WITH THE REQUIREMENTS OF AS/NZS 4013 WHERE REQUIRED BY THE REGULATORY AUTHORITY, I.E. THE APPLIANCE SHALL BE IDENTIFIABLE BY A COMPLIANCE PLATE WITH THE MARKING 'TESTED TO AS/NZS 4013'.**

**ANY MODIFICATION OF THE APPLIANCE THAT HAS NOT BEEN APPROVED IN WRITING BY THE TESTING AUTHORITY IS CONSIDERED TO BE IN BREACH OF THE APPROVAL GRANTED FOR COMPLIANCE WITH AS/NZS 4013.**

**CAUTION: MIXING OF APPLIANCE OR FLUE SYSTEM COMPONENTS FROM DIFFERENT SOURCES OR MODIFYING THE DIMENSIONAL SPECIFICATION OF COMPONENTS MAY RESULT IN HAZARDOUS CONDITIONS. WHERE SUCH ACTION IS CONSIDERED, THE MANUFACTURER SHOULD BE CONSULTED IN THE FIRST INSTANCE.**

**CAUTION: THIS APPLIANCE SHOULD NOT BE OPERATED WITH CRACKED AND BROKEN COMPONENTS, e.g. GLASS PANELS OR CERAMIC TILES, MAY RENDER THE INSTALLATION UNSAFE.**

**WARNING: ANY MODIFICATION OF THE APPLIANCE THAT HAS NOT BEEN APPROVED IN WRITING BY THE TESTING AUTHORITY IS CONSIDERED AS BREACHING AS/NZS 4013.**

**WARNING: DO NOT USE FLAMMABLE LIQUIDS OR AEROSOLS TO START OR REKINDLE THE FIRE.**

**WARNING: DO NOT USE FLAMMABLE LIQUIDS OR AEROSOLS IN THE VICINITY OF THIS APPLIANCE WHEN ITS OPERATING.**

**WARNING: DO NOT STORE FUEL WITHIN HEATER INSTALLATION CLEARANCES.**

**WARNING: OPEN AIR CONTROLS AND DAMPER WHEN FITTED BEFORE OPENING FIRING DOOR.**

**WARNING: FOR OPTIMUM PERFORMANCE FUEL MUST BE LOADED SO THE LOGS LAY "FRONT TO REAR" IN PREFERENCE TO LAYING ACROSS THE WIDTH OF THE FIREBOX. SPACES SHOULD BE LEFT BETWEEN THE LOGS TO ENABLE OXYGEN TO GET TO AS MUCH OF THE SURFACE OF THE FUEL AS POSSIBLE.**

**CAUTION: THIS APPLIANCE SHOULD BE MAINTAINED AND OPERATED AT ALL TIMES IN ACCORDANCE WITH THESE INSTRUCTIONS.**

**CAUTION: THE USE OF SOME TYPES OF PRESERVATIVE-TREATED WOOD AS A FUEL CAN BE HAZARDOUS.**

## Component list for ZC casing

- 1x bag of self tapping screws
- 1x top panel
- 2x side panels
- 1x base panel
- 2x large support rails
- 4x fan brackets (with riv-nuts fitted)
- 2x thin ventilation covers (case base)

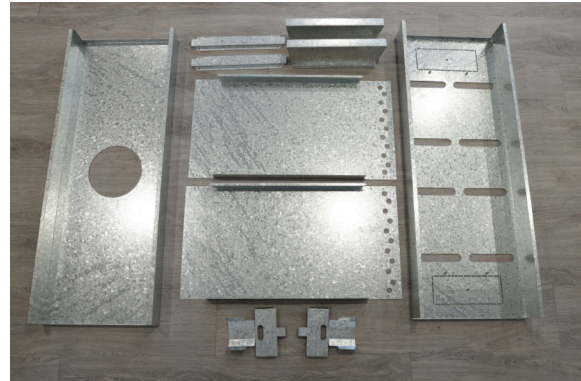

## Component list for base

- 8x long rails with fold out tabs
- 8x medium vertical rails
- 8x short horizontal rails



## Constructing the base stand

### Step 1.

Layout all base rails to setup 4 identical squares and begin screwing them together with the supplied self tapping screws. Pay attention to the pre-drilled holes that have two sizes. The smaller holes are for the screw thread to bind to tightly whereas the screw will pass through the larger holes and not bind.



### Step 2.

Attach short horizontal rails to each corner and join second square frame to complete a cube. Repeat for the second base.



## Step 3.

Layout your two base platforms with seismic restraint tabs to the floor and immediately below the zc case floor panel. Place the floor panel on top. Fold up tabs to centre but do not secure to base yet.



## Step 4.

Place and secure centre vent covers and unit support rails with supplied self tapping screws. Units support rails may twist if the screws aren't centred correctly. If this occurs, back each screw off, place pressure in the appropriate direction to correct it and re-tighten.



## Step 6.

Slip a side panel between the fold gap, line up the screw holes including the foldup tabs and screw in to secure.



# ZERO CLEARANCE CASING ASSEMBLY

## Step 7.

Note the locating tabs for the top panel which will assist in lining it up for fixing. Place top panel onto sides ensuring the top panel fold goes over side edge.



## Step 8.

Line up pre-drilled holes and fix using supplied self tapping screws.

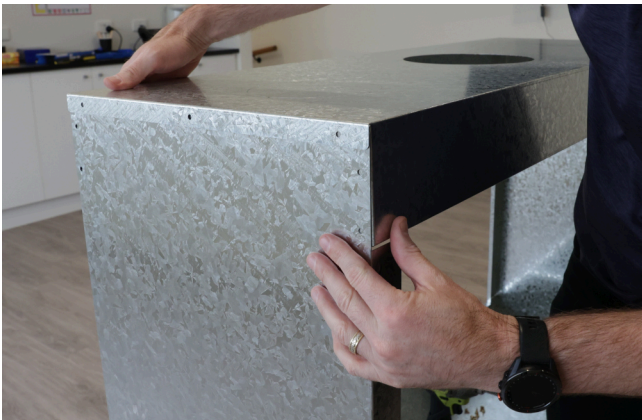

## Step 9.

Place zero clearance case into position and fix to the floor protector using lower foldout tabs and appropriate screws or masonry anchors

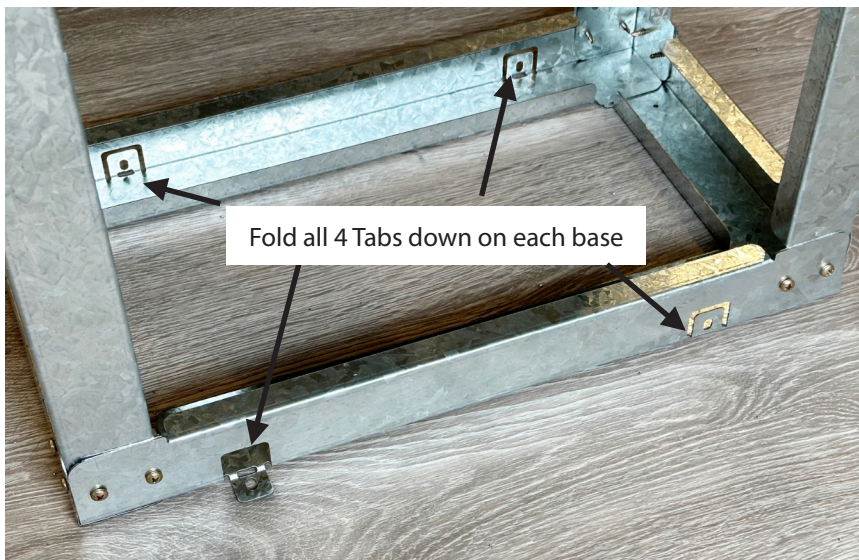



# ZERO CLEARANCE CASING ASSEMBLY

Step 10.

If installing dual fans, do this now by attaching two brackets to each fan.

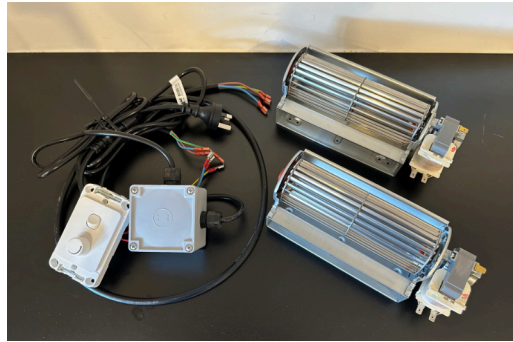

Open both openings in the zero clearance base air flow and servicing access

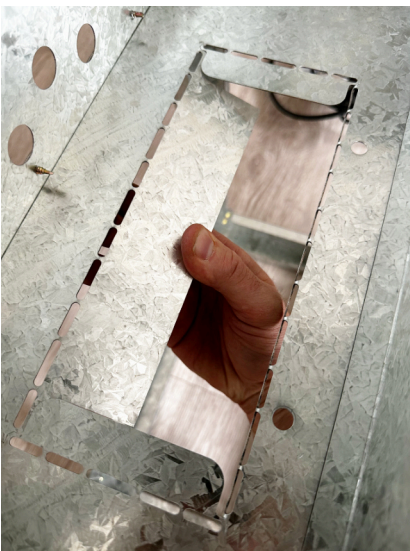

If installing the fans after the heater is in place or for servicing the fans from under the unit, Insert fan motor end first into the zero clearance casing floor. Otherwise, if the unit is not yet in place, it is much easier to install from the top. Secure to the zero clearance casing using the supplied bolts through the bottom of the casing into the nutserts attached to the fan brackets.

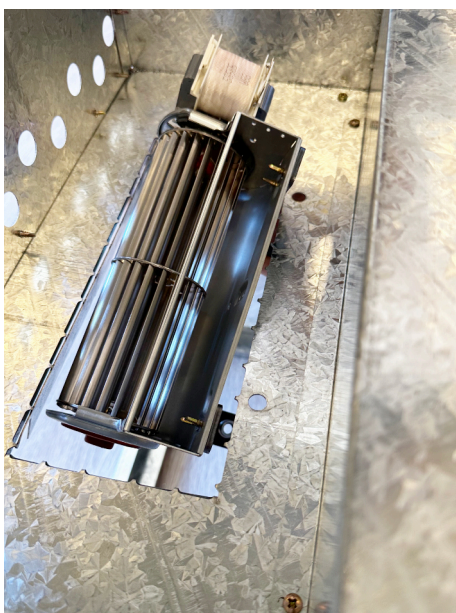

**Note: Keep in mind that when installing the dual fans, consideration must be given on access for servicing either via creating wood storage below the unit on at least one side or integrating self supplied removable vents for each fan.**

Install fan power cable now onto both fans chasing the wiring through the zero clearance case bottom. Ensure to keep the cable away from the ventilation openings so as to not obstruct the air flow. Junction box positioned to the side planned for running the power and speed controller.

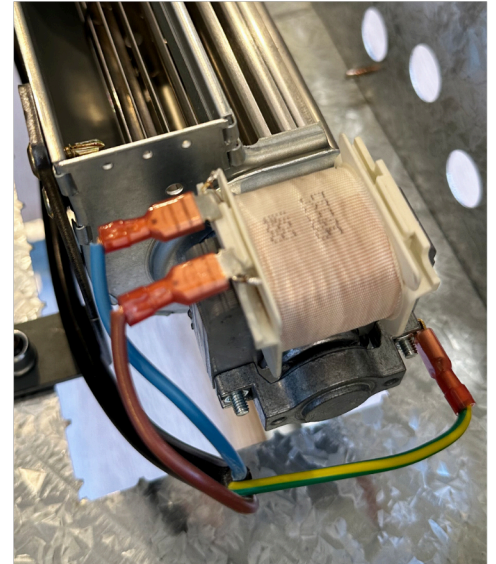
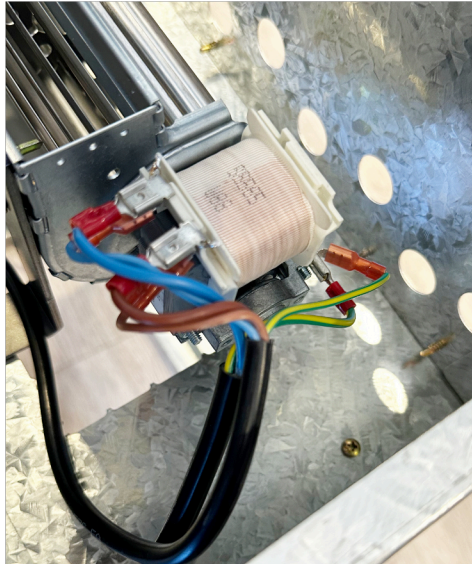

Step 11.

Place unit inside zero clearance casing. Due to the weight of the firebox (200kg) it is highly recommended to remove as much weight as possible from the unit (bricks, baffle and glass door) and use mechanical lifting aids. It is possible to remove the firebox from the outer shell of the fireplace. Refer to pages ## unit stripping steps.

Leaving the top panel off allows for the use of mechanical lifting aids to help position the firebox inside the casing / wall cavity if possible.

The firebox should overhang each side by roughly 10mm to allow for the optional surround to finish flush when using a 10mm finishing material. Pic below for reference.



Lifting aid examples

## Step 12.

The flue requires stand-off brackets which are included with the kit. Position the standoff brackets as pictured below.

The brackets are secured to the 10 inch flue pipe using self tapping screws or rivets. The 8 inch flue pipe and brackets pass through the casing and rest on top of the fire box. The brackets will stand the 8 inch flue pipe off the top of the firebox the required distance.

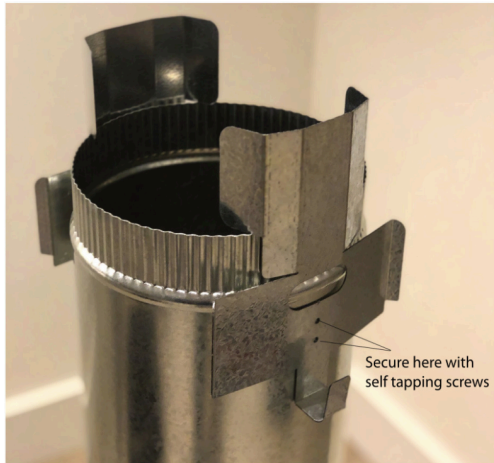

Once the 10" and 8" flues are secured together using self-tapping screws or rivets, position the flue pipes on top of the zero clearance casing and lower into position. The brackets will locate the flue correctly, the first step of the bracket will stand the flue off the firebox.

Using a suitable heat resistant sealant rated above 500°C, seal the 8" flue pipe to the zero clearance casing as marked below in blue.

The second step on the flue bracket will stand the 10" flue pipe off the zero clearance casing as shown.



Use heat resistant sealant to seal 8" flue pipe to casing

Once the flue has been positioned and sealed to the top of the zero clearance casing, lower the 6" Stainless flue pipe down inside the 8" flue pipe and seat fully on the top of the fireplace flue spigot.

Continue to run the three layers of flue in accordance with AS/ NZS 2918.

Typical flue size for triple cased flue  
152mm | 200mm | 250mm  
6in | 8 1/4 | 10 1/4

For flue system installation, please follow manufacturers instructions.

Below relates specifically to the active flue connection.



Lower channel

The active 6" flue seats over the flue starter spigot, the flue crimp will slide down and rest in the lower channel.

Friction fitment secures the flue on the spigot, no sealant required.

If active flue is found to be slack or loose, cut off the crimp on the first length to ensure air-tight fitment.

*Flue spigot removal for demonstration purposes only. Not required for installation of the fireplace unless for seismic restraint requirements as per page 22.*



Flue seated correctly.

## MINIMUM HEIGHT OF FLUE SYSTEM EXIT

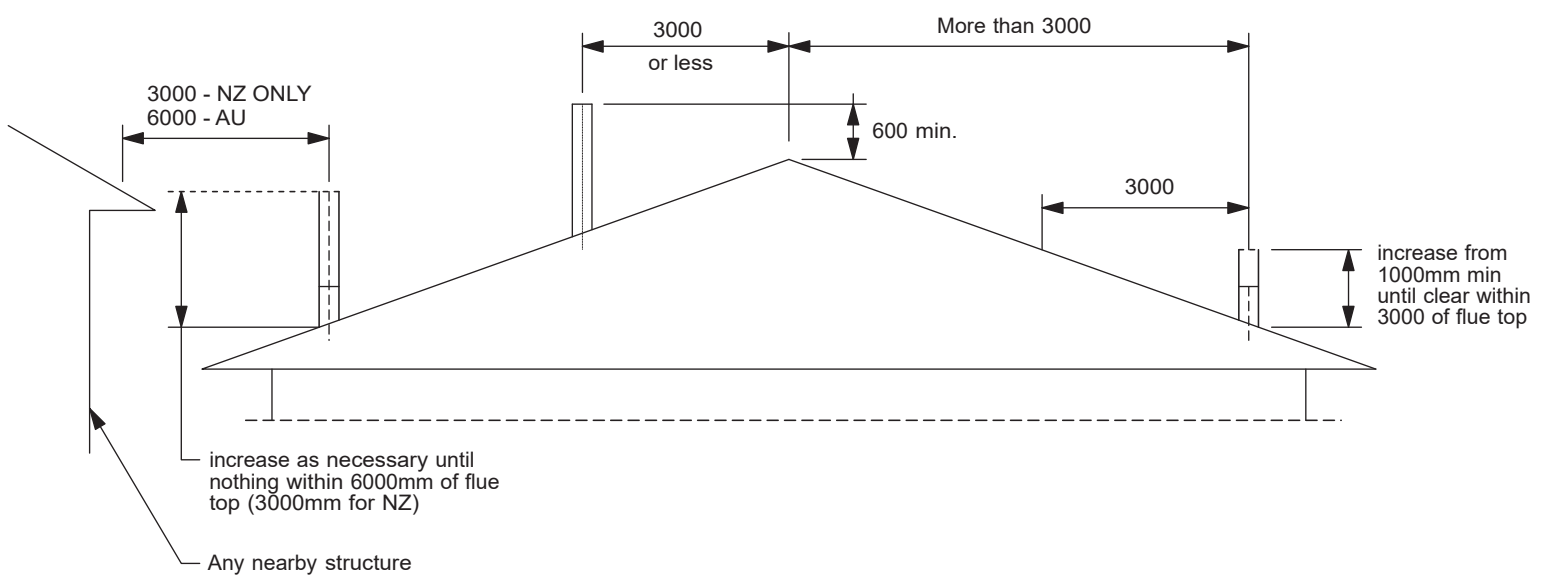

**Note:** *Keep in mind that when installing the dual fans, consideration must be given on access for servicing either via creating wood storage below the unit on at least one side or integrating self supplied removable vents for each fan.*

Optional fans should not be used within 45 minutes of starting the fireplace, this allows the firebox to warm up prior to heat being pulled from the heat exchanger. Using the optional fans prior will reduce the heat output of the fire and delay the warm up process dramatically.

**CAUTION:** *Fans should be switched off when the fireplace door is opened. Failure to do so may result in smoke being blown into the room.*

## WIRING DIAGRAM

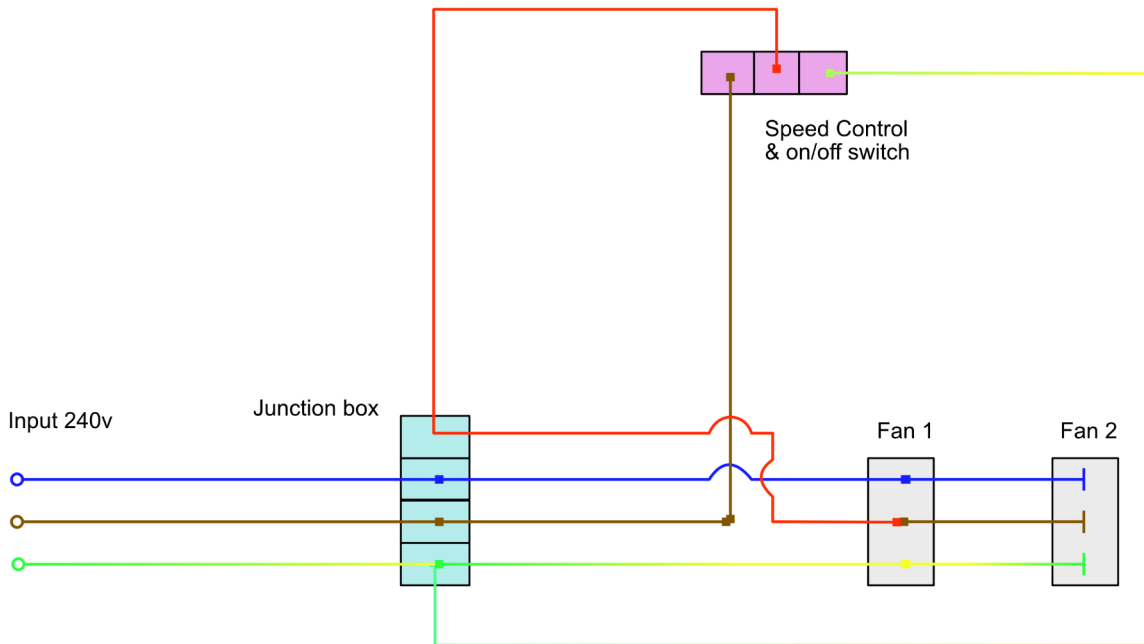

## Before lighting the first fire

If the stove was stored in a cold environment (car, store, etc.) before the first lighting, keep it at room temperature for about 3 hours to equalise moisture condensation and surface temperature of the parts. Otherwise, there is a risk of damage to the glass or lining of the stove.

During the first lighting, the paint coating will go through a curing process. The stove paint will emit an odor for at least 4 hours as it adheres to the steel. Ensure to ventilate the room during this time.

## Lighting your fire

- Ensure the Air Slide is in the open or high position. (pulled out fully towards you).
- In firebox lay your fire lighters 10 to centimetres apart. Do not use newspaper as a fire lighter.
- Add a mixture of soft wood and hardwood kindling in a criss cross pattern above the firelighters. Softwood kindling allows for fire to light quicker and burn hotter, mixing in some kindling size hardwood helps the coals retain more heat for longer.
- Light fire with match or gas lighter, when fire is ablaze close the door, but do not latch the door. Leave for 5-10 minutes maximum and do not leave unattended.
- Load pieces of hardwood that are no wider than a drink can in a criss cross pattern.
- Latch the door and leave latched for 30 minutes. If your heater has a fan, do not run the fan for at least 45 minutes.
- After 30 minutes add the large pieces of hardwood. These pieces should be no bigger than a loaf of bread. Close and latch door after loading.
- After 45 minutes you can adjust the air slide to slow fire down and find your comfort level. If you have a fan fitted you can now turn it on.

If too little wood and firelighters are used during lighting or the pieces are too large, the optimal operating temperature will not be reached. This can lead to poor combustion, high soot formation and the extinguishing of the fire after closing the door.

Slow combustion fireplaces with wide door openings are prone to smoke spillage occasionally when the door is opened during lighting and reloading. This occurs due to a pressure imbalance when opening the door as cool air rushes in.

Avoid opening the door when there is visible smoke/flame to reduce this symptom. It is good practice to only reload when fuel is at coaling phase.

*Only load fuel through one door at a time.*

## Tips on choosing firewood

How long a tree has been felled or dead for does not indicate how dry the wood is. The best way to dry wood is to split it and expose the inner core allowing the sun to dry the wood naturally.

Good wood merchants will split the wood for you, but may not season it for you.

The amount of you pay for your wood or the appearance of the wood does not justify how dry the wood is. The only way to know how dry your wood is, is to use a moisture meter measuring from the inner core after splitting the piece of wood you are testing.

### Only burn wood under 20% moisture.

Anything over 20% and your wood heater will not work efficiently. The energy from the fire will be used to reduce moisture in your wood and not produce heat for your house.

Store your wood for at least 12 months after you have purchased it. Optimum moisture content is between 15-18%. Wood under 15% will have a shorter overall burn time than wood around 20%.

Never burn treated wood or painted wood.

## Combustion air

The 3 elements required for fire are Fuel, Heat and Oxygen. When a fire is started within a slow combustion heater, the heat rises in the flue system creating a vacuum within the firebox. This vacuum creates positive pressure or 'draw' which pulls oxygen in to replace itself and create the balance of air to keep the fire running.

In tightly sealed homes, fresh air supply to the unit may be insufficient due to an air pressure imbalance which can affect the operation of the stove.

This stove has the possibility of connecting directly to outside the envelope of the home to supply combustion air. This is via the 99mm diameter central air duct neck located on the base of the unit which can be connected through the sub floor.

To ensure a central air supply, the duct must not be longer than 3 m and have too many bends. The minimum duct diameter is 80 mm.

*The central air duct must be led outdoors or into a well-ventilated room inside the building (cellar, utility room, etc.).*

## ! NOTICE

Over firing the unit and continuously running the unit on high with an overloaded firebox for extended periods of time can damage the unit.

This picture shows the firebox fully loaded.

Note the red line which indicates a gap between the loaded fuel and the baffle top and the clear path to the tertiary air tube at the rear.

Loading fuel which touches the roof baffle or the rear tertiary air tube is considered to be overloaded and can result in overfiring of the product causing damage to the unit and voiding the warranty.



**CAUTION:** Only open one door to reload the fireplace when the unit is in operation.

**NOTICE:** This fireplace is not designed to be operated as an open fire and will spill smoke if the unit is operated with the door in the open position

The stove and flue pipes must be inspected once a year or more frequently if required.

The chimney needs to be cleaned regularly by a chimney sweep.

Before the heating season, thoroughly clean the entire fireplace from ash and soot with a brush or vacuum cleaner. Ensure that ash that has fallen between fire bricks is removed.

Inspect the fire bricks and firebox.

Only clean the glass when the stove is cold and never use abrasive cleaners.

The stove surface can be cleaned with a damp cloth if necessary with a mild soap solution. Scratches or surface rust should be lightly sanded and re-sprayed with the matched colour, Anthracite grey.

## For firebrick removal, please follow the following guide

1. Remove baffle retainer on one side whilst supporting the baffle bricks.



1-1. Support bricks whilst pulling retainer towards the face of the unit



1-1. Pull the retainer to the open side and then back out carefully

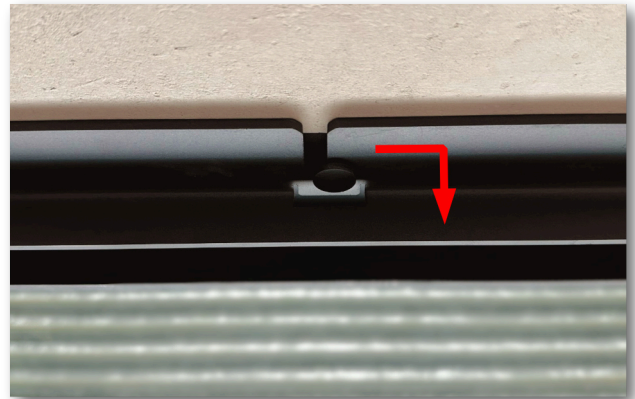

1-1. Be careful to not allow bricks to free-fall. Repeat process for both sides





2. Remove both left and right side baffle spacer brackets by lifting up and out.



3. Lean side bricks to the side and lift out one at a time

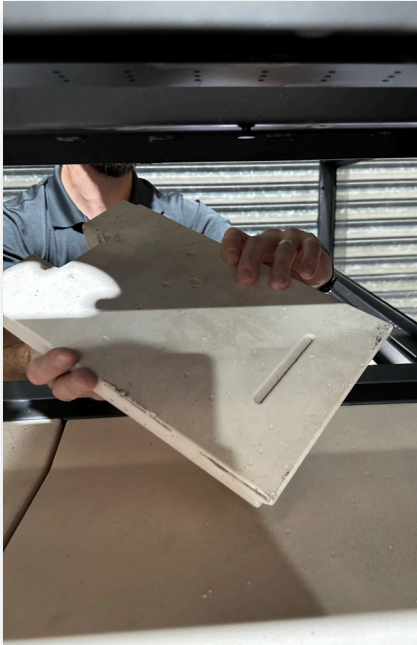

4. Lever base brick up and remove. Then remove second base brick



If not utilising either of the pedestal base options and opting to install the unit directly onto a floor protector, the following instructions can be followed to seismically restrain the unit through the outer casing.

1. Remove all bricks as per Firebrick Removal steps on page 20-21.
2. Remove flue spigot by removing all four 10mm bolts
3. Remove both doors and place in a safe place. Mark the door hinge location for easy re-fitting.  
Loosen front 10mm positioning bolt first, then rear locking bolt whilst supporting the door.



4. Remove burn rate control handle using T20 torx driver bit.

5. Locate and remove both anchor point cover plates on the sides of the firebox using T20 torx driver bit.

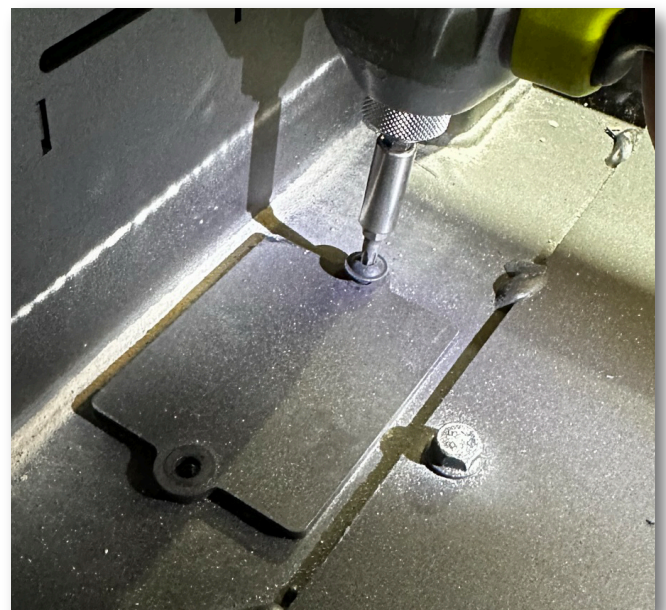

6. Using a 17mm socket, remove firebox anchor bolts from each side of the firebox

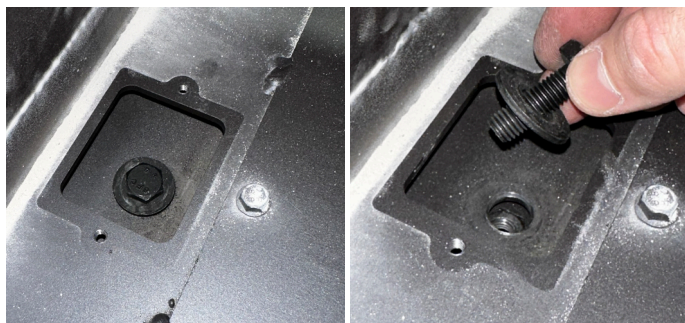

7. Remove 4x cover plates from each corner with T20 torx driver bit.

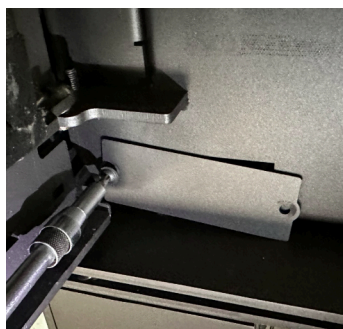

8. Using 17mm open ended spanner, wind spacing screw downwards (left turn) to allow firebox to move



9. Firebox can now be pulled through the outer casing either completely or partially to expose the pre-drilled seismic restraint holes.

10. Secure outer casing now to the floor using (not supplied) 8mm masonry anchors.

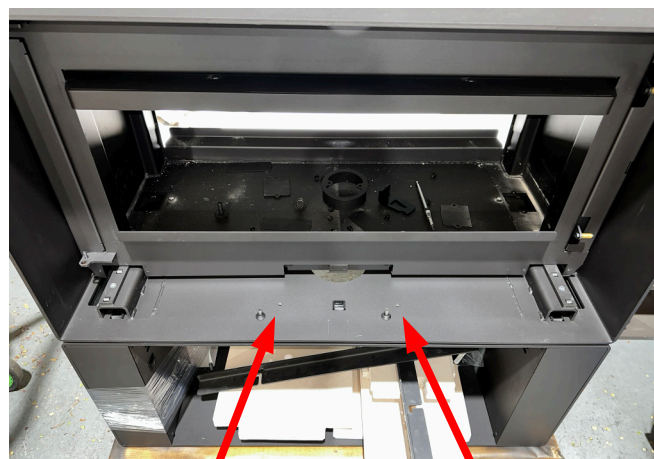

11. Once anchored, re-centre the firebox inside the casing and follow the steps in reverse including re-fitting the firebricks.



## VisionLINE Wood Stove Warranty

VisionLINE extends the following manufacturer's warranty for wood hearth appliances that are purchased from a VisionLINE authorized dealer.

VisionLINE warrants to the original owner of the VisionLINE appliance at the site of installation, and to any transferee taking ownership of the appliance at the site of installation within two years following the date of original purchase, that the VisionLINE appliance will be free from defects in materials and workmanship at the time of manufacture.

After installation, if covered components manufactured by VisionLINE are found to be defective in materials or workmanship during the applicable warranty period, VisionLINE will, at its option, repair or replace the covered components. VisionLINE, at its own discretion, may fully discharge all of its obligations under this manufacturer's warranty by replacing the product itself or refunding the verified purchase price of the product itself. The maximum amount recoverable under this warranty is limited to the purchase price of the product. This warranty is subject to conditions, exclusions and limitations as described below.

Warranty coverage begins on the date of original purchase. In the case of new home construction, coverage under this manufacturer's warranty begins on the date of first occupancy of the dwelling or six months after the sale of the product by an independent, authorized VisionLINE dealer/ distributor, whichever occurs earlier. The warranty period for this manufacturer's warranty shall commence no later than 12 months following the date of product shipment from VisionLINE AU, regardless of the installation or occupancy date.

The term "Limited Lifetime" in the table below is defined as: 10 years from the beginning date of warranty coverage for wood appliances. These time periods reflect the minimum expected useful lives of the designated components under normal operating conditions.

10 year structural warranty on the firebox construction including weldment.

5 year warranty on tertiary air tube, baffle and bricks. (labour for 3 years)

2 year warranty on fans and electrical components. (labour for 1 year)

## OTHER RIGHTS

The VisionLINE manufacturer's warranty is in addition to other rights and remedies that you may have under Australian law.

Our goods come with guarantees that cannot be excluded under the Australian Consumer Law. You are entitled to a replacement or refund for a major failure and for compensation for any other reasonably foreseeable loss or damage. You are also entitled to have the goods repaired or replaced if the goods fail to be of acceptable quality and the failure does not amount to a major failure.

### WARRANTY CONDITIONS AND EXCLUSIONS:

The VisionLINE manufacturer's warranty only covers VisionLINE appliances that are purchased through a VisionLINE authorized dealer or distributor. A list of VisionLINE authorized dealers is available on the VisionLINE branded websites.

This warranty is only valid while the VisionLINE appliance remains at the site of original installation.

### WARRANTY EXCLUSIONS:

This VisionLINE manufacturer's warranty does not cover the following:

- Changes in surface finishes as a result of normal use. As a heating appliance, some changes in color of interior and exterior surface finishes may occur. This is not a flaw and is not covered under warranty.
- Damage to printed, plated, or enamelled surfaces caused by fingerprints, accidents, misuse, scratches, melted items, or other external sources and residues left on the plated surfaces from the use of abrasive cleaners or polishes.
- Repair or replacement of parts that are subject to normal wear and tear during the warranty period. These parts include: paint, gaskets, firebricks, grates and the discoloration of glass.
- Minor expansion, contraction, or movement of certain parts causing noise. These conditions are normal and complaints related to this noise are not covered by this warranty.

---

### **WARRANTY EXCLUSIONS cont.**

- Damages resulting from: (1) failure to install, operate, or maintain the appliance in accordance with the installation instructions, operating instructions, and listing agent identification label furnished with the appliance; (2) failure to install the appliance in accordance with local building codes; (3) shipping or improper handling; (4) improper operation, abuse, misuse, continued operation with damaged, corroded or failed components, accident, or improperly/incorrectly performed repairs; (5) environmental conditions, inadequate ventilation, negative pressure, or drafting caused by tightly sealed constructions, insufficient make-up air supply, or handling devices such as exhaust fans or forced air furnaces or other such causes; (6) use of fuels other than those specified in the operating instructions; (7) installation or use of components not supplied with the appliance or any other components not expressly authorized and approved by VisionLINE (8) modification of the appliance not expressly authorized and approved by VisionLINE in writing; and/or (9) interruptions or fluctuations of electrical power supply to the appliance.
- Non VisionLINE venting components, hearth components or other accessories used in conjunction with the appliance.
- Any part of a pre-existing fireplace system in which an insert appliance is installed.
- Removal, installation, reinstallation, set up or any other costs associated with a claim including travel and shipping charges for parts.
- VisionLINE's obligation under this warranty does not extend to the appliance's capability to heat the desired space. Information is provided to assist the consumer and the dealer in selecting the proper appliance for the application. Consideration must be given to appliance location and configuration, environmental conditions, insulation and air tightness of the structure.

### **This warranty is void if:**

- The appliance has been over-fired or operated in atmospheres contaminated by chlorine, fluorine, or other damaging chemicals. Over-firing can be identified by, but not limited to, warped plates or tubes, rust coloured cast iron, bubbling, cracking and discoloration of steel finishes.
- The appliance is subjected to prolonged periods of dampness or condensation.
- There is any damage to the appliance or other components due to water or weather damage which is the result of, but not limited to, improper chimney or venting installation.

### **HOW TO CLAIM**

- To make a claim against this warranty, contact your local distributor during regular business hours. See addresses below for a dealer nearest you.
- Additional service fees may apply if you are seeking warranty service from a dealer other than the dealer from whom you originally purchased the product.
- Check with your distributor in advance for any costs to you when arranging a warranty call. Travel and shipping charges for parts are not covered by this manufacturers warranty.
- VisionLINE will assess your claim. VisionLINE (AU) or The Fireplace (NZ) may need to inspect the product as part of the assessment of your claim. If the product requires inspection, VisionLINE or The Fireplace will discuss with you the best way for this to occur.
- To make a claim under this manufacturer's warranty, you must be able to prove when you purchased the product. The easiest way to do this is through your original proof of purchase, for example your invoice or receipt. However, if you do not have your original proof of purchase VisionLINE or Jetmaster may accept other evidence of the date of purchase.



VisionLINE Australia  
PO Box 5051 Burnley, 3121  
Phone: (03) 9429 5573  
Email: [info@visionlinefire.com.au](mailto:info@visionlinefire.com.au)  
Web: [visionlinefire.com.au](http://visionlinefire.com.au)

The Fireplace  
12 Tawari st, Mt Eden, 1024  
Phone: (09) 623 6990  
Email: [sales@thefireplace.co.nz](mailto:sales@thefireplace.co.nz)  
Web: [thefireplace.co.nz](http://thefireplace.co.nz)